

CODE SCANNER™

Congratulations on purchasing your Actron Code Scanner for accessing engine trouble codes required for repairing vehicles equipped with computers. Your Actron Code Scanner is made by Actron, the largest and most trusted name in automotive diagnostic equipment for the home mechanic. You can have confidence this product maintains the highest quality in manufacturing, and will provide you years of reliable service.

This instruction manual is divided into several key sections. You will find detailed steps on using the Code Scanner and important information about trouble code meanings, how a computer controls engine operation, and more!

Identifying the problem is the first step in solving that problem. Your Actron Code Scanner can help you determine by accessing the engine computer trouble codes. Armed with that knowledge, you can either refer to an appropriate service manual or discuss your problem with a knowledgeable service technician. In either event you can save yourself a lot of valuable time and money in auto repair. And feel confident that your vehicle's problem has been fixed!

Actron offers a complete line of high quality automotive diagnostic and repair equipment. See your local Actron dealer for other Actron products.

CONTENTS

1	About Codes	3
2	When to Read Codes	5
3	Using Codes	7

TOYOTA SECTION

4	Vehicle Preparation	9
5	Reading Codes	11
6	Code Meanings	22

HONDA SECTION

7	Vehicle Preparation	28
8	Reading Codes	30
9	Code Meanings	40

NISSAN SECTION

10	Vehicle Preparation	43
11	Reading Codes	46
12	Code Meanings	72

REFERENCE SECTION

13	Computer Basics	74
14	Glossary	79

Instrucciones en español 89

Instructions en français 177

General Safety Guidelines to follow when working on vehicles

- Always wear approved eye protection.
- Always operate the vehicle in a well ventilated area.
Do not inhale exhaust gases – they are very poisonous!
- Always keep yourself, tools and test equipment away from all moving or hot engine parts.
- Always make sure the vehicle is in **park** (Automatic transmission) or **neutral** (manual transmission) and that the **parking brake is firmly set**. Block the drive wheels.
- Never leave vehicle unattended while running tests.
- Never lay tools on vehicle battery. You may short the terminals together causing harm to yourself, the tools or the battery.
- Never smoke or have open flames near vehicle.
Vapors from gasoline and charging battery are highly flammable and explosive.
- Always keep a fire extinguisher suitable for gasoline/electrical/chemical fires handy.
- Always turn ignition key OFF when connecting or disconnecting electrical components, unless otherwise instructed.
- Always follow vehicle manufacturer's warnings, cautions and service procedures.

CAUTION:

Some vehicles are equipped with safety air bags.

You must follow vehicle service manual cautions when working around the air bag components or wiring. If the cautions are not followed, the air bag may open up unexpectedly, resulting in personal injury. Note that the air bag can still open up several minutes after the ignition key is off (or even if the vehicle battery is disconnected) because of a special energy reserve module.

About Codes

Where do they come from and what are they for?

Engine computers can find problems

The computer system in today's vehicles does more than control engine operation - it can help you find problems, too! Special testing abilities are permanently programmed into the computer by factory engineers. These tests check the components connected to the computer which are used for (typically): fuel delivery, idle speed control, spark timing and emission systems. Mechanics have used these tests for years. Now you can do the same thing by using the Actron Code Scanner!

Engine computers perform special tests

The engine computer runs the special tests. The type of testing varies with manufacturer, engine, model year etc. There is no "universal" test that is the same for all vehicles. The tests examine *INPUTS* (electrical signals going *INTO* the computer) and *OUTPUTS* (electrical signals coming *OUT* of the computer). Input signals which have "wrong" values or output circuits which don't behave correctly are noted by the test program and the results are stored in the computer's memory. These tests are important. The computer can not control the engine properly if it has bad inputs or outputs!

Code numbers give test results

The test results are stored by using code numbers, usually called "trouble codes" or "diagnostic codes." For example, a code 23 might mean "throttle position sensor signal voltage is incorrect." Code meanings are listed in Sections 6, 9 and 12. Specific code definitions vary with manufacturer, engine and model year, so you may want to refer to a vehicle service manual for additional information. These manuals are available from the manufacturer, other publishers or your local public library. (See manual listing on page 4.)

Read Codes with the Code Scanner

You obtain trouble codes from the engine computer memory by using the Actron Code Scanner tool. Refer to section 5, 8 or 11 for details. After you get the trouble codes, you can either:

- Have your vehicle professionally serviced. Trouble codes indicate problems found by the computer.
- or,
- Repair the vehicle yourself using trouble codes to help pinpoint the problem.

Trouble Codes and Diagnostics help you fix the problem

To find the cause of the problem yourself, you need to perform special test procedures called "diagnostics". These procedures are in the vehicle service manual. There are many possible causes for any problem. For example, suppose you turned on a wall switch in your home and the ceiling light did not turn on. Is it a bad bulb or light socket? Is the bulb installed correctly? Are there problems with the wiring or wall switch? Maybe there is no power coming into the house! As you can see, there are many possible causes. The diagnostics written for servicing a particular trouble code take into account all the possibilities. If you follow these procedures, you should be able to find the problem causing the code and fix it if you want to "do-it-yourself."

Actron makes it easy to fix computer-controlled vehicles

Using the Actron Code Scanner to obtain trouble codes is fast and easy. Trouble codes give you valuable knowledge - whether you go for professional vehicle servicing or "do-it-yourself." Now that you know what trouble codes are and where they come from, you are well on your way to fixing today's computer controlled vehicles!

Vehicle Service Info

The following is a list of publishers who have service manuals for your specific vehicle. Write or call them for availability and prices, specifying the make, style, model year, and VIN (Vehicle Identification Number) of your vehicle.

Vehicle Service Manuals

Chilton Book Company

Chilton Way
Radnor, PA 19089

Haynes Publications

861 Lawrence Drive
Newbury Park, CA 91320

"Electronic Engine Controls"
"Fuel Injection and Feedback Carburetors"
"Fuel Injection and Electronic Engine Controls"
"Emissions Control Manual"
...or similar titles

Cordura Publications

Mitchell Manuals, Inc.
Post Office Box 26260
San Diego, CA 92126

Motor's Auto Repair Manual

Hearst Company
250 W. 55th Street
New York, NY 10019

Vehicle Service Manuals from Toyota, Honda, Nissan:

Toyota Motor Corporation

Toyota Service Publications
750 W. Victoria St.
Compton, CA 90220-5538

Honda Motor Co., Ltd.

Helm Incorporated
Post Office Box 07280
Detroit MI 48207

Nissan North America, Inc.

Dyment Distribution Services
C/O Nissan
20770 Westwood Drive
Strongsville, OH 44136

When to Read Codes

Use the Code Scanner to read computer trouble codes if...

- The “Check Engine” light comes ON or,
- Vehicle engine is running poorly (for vehicles without a “CHECK ENGINE” LIGHT.

The “Check Engine” light

The “CHECK” engine dashboard light tells you when to use the Code Scanner tool.

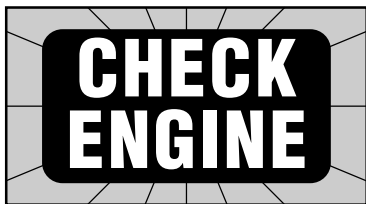

The light may be colored amber or red, labeled with a small engine picture, called “CHECK ENGINE”, “PGM-FI”, or “PGM-CARB” on some vehicles.

What the “CHECK” Engine Light Does...

...when no problem is spotted –

Normal operation:

- Light **OFF** – when the engine is **RUNNING**.

This means the computer sees no problem at the present time.

- Light **ON** — when the ignition key is in the **ON** position, but the engine is **OFF**. (For example, before you start the engine.) This is a normal test of all dashboard message lights. (Depending upon vehicle, light will go out after 2 seconds or when engine is started.)

If the “CHECK” engine light does not come on, you have a problem which needs repair. Refer to your vehicle service manual. Look in sections called

“Computerized Engine Controls”, “Electronic Engine Controls”, “Tune-Up Information” or similar.

What the “CHECK” Engine Light Does...

...when a problem is spotted!

- Light **ON** and stays **ON** (when the engine is **RUNNING**)
 - The computer sees a problem that does not go away. (A “hard” failure.)
 - The light will stay on as long as the problem is present.
 - A trouble code is stored in computer memory. (A “hard” code.)
 - Use the Code Scanner at the earliest convenient time to obtain the code.
- or...
- Light **ON** and then goes **OFF** (when the engine is **RUNNING**)
 - The computer saw a problem, but the problem went away. (An “intermittent” failure.)
 - A trouble code is stored in computer memory. (An “intermittent” code.)
 - The light went out because the problem went away, but the code stays in memory.
 - Use the Code Scanner at the earliest convenient time to obtain the code. Note that the computer will automatically erase codes after several restarts (typically 30 to 100) if the problem does not return. (Exception: some early Honda systems do not have this automatic code erase feature.)

A Poorly Running Engine

Some vehicles do not have a “CHECK” engine light to let you know when trouble codes are stored. If your engine is

running poorly, problems in the computer system MAY be the cause.

See if any of the following symptoms apply to your vehicle.

- Is the gas mileage significantly lower than it should be?
- Is it hard to start cold?, hot?, always?
- Has it recently failed an emissions test?
- Does it falter or stumble when accelerated?
- Does it lunge or surge while trying to maintain a steady speed?
- Has it lost power?

Always check the simple things first:

- Is the air filter clean? A dirty air filter will degrade engine performance.
- Are all vacuum hoses correctly installed and in good condition?
- Have the spark plugs, spark plug wires, distributor cap, and rotor (if used) been changed according to the manufacturer's recommendations?
- Is the tire pressure correct? Low tire pressure can affect power and gas mileage.

Make any necessary repairs before proceeding to read trouble codes.

Code Scanner Tools

The tools illustrated below are part of the Code Scanner package. The "Code Reading" sections of this manual list procedures and tell you what tools are required.

TOYOTA section starts on	page 9
HONDA section starts on	page 28
NISSAN section starts on	page 43



Using Codes

Using Trouble Codes to Pinpoint Problems

There are two types of codes

- **“Hard” codes** - codes for problems which are present **now**.

“Hard” problems make the “Check Engine” light come on and stay on. A trouble code is stored in computer memory. The light will stay on as long as the problem is present.

- **“Intermittent” codes** - codes for problems which happened in the past, but are **not** happening now.

When the problem first appears the “Check Engine” light will come on and a trouble code will be stored in computer memory. When the problem goes away, the light will turn off, but the code will **stay** in memory.

You troubleshoot the “hard” problems differently from the “intermittent” ones.

Do a thorough visual and “hands-on” underhood inspection before starting any diagnostic procedure!!

Dealing with “Hard” Codes

These codes are for problems which are happening now.

- Refer to the vehicle service manual diagnostic code charts.
- Follow all the steps in the diagnostic procedure for the trouble code.
- Mechanical problems often generate trouble codes! Be sure to inspect the mechanical things suggested in the diagnostic procedures. Mechanical problems can make a good sensor send an incorrect signal to the computer.
- Do a thorough visual and “hands-on” underhood inspection before starting any diagnostic procedure! You can often find the problem cause and fix it by doing this. (See “Inspection Checks”.)
- Be sure to erase the trouble codes from computer memory after

completing repair work. (Refer to “Erasing Trouble Codes after Repair” in the “Reading Codes” section for your vehicle.)

Dealing with “Intermittent” Codes

These codes are for problems which happened in the past, but are not present now.

- Usually these problems are due to loose connections or bad wiring. The problem cause can often be found with a thorough visual and “hands-on” inspection. (See “Inspection Checks” below.)
- Refer to the vehicle service manual diagnostic code section. You can not use the code chart procedures because they are for “hard” problems - those which are present now. However, the charts have suggestions for dealing with intermittents and can tell you where bad connections, etc., might exist.
- Be sure to erase the trouble codes from computer memory after completing repair work. (Refer to “Erasing Trouble Codes after Repair” in the “Reading Codes” section for your vehicle.)

Inspection Checks

Doing a thorough visual and “hands-on” underhood inspection before starting any diagnostic procedure is essential!!

You can find the cause of many drivability problems by just looking, thereby saving yourself a lot of time.

- Has the vehicle been serviced recently? Sometimes things get reconnected in the wrong place, or not at all.
- Don’t take shortcuts. Inspect hoses and wiring which may be difficult to see because of location beneath air cleaner housings, alternators and similar components.

- *Inspect all vacuum hoses for:*

- Correct routing. Refer to vehicle service manual, or Vehicle Emission Control Information(VECI) decal located in the engine compartment.

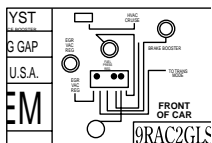

- Pinches and kinks.
- Splits, cuts or breaks.

- *Inspect wiring for:*

- Contact with sharp edges. (This happens often.)



- Contact with hot surfaces, such as exhaust manifolds.

- Pinched, burned or chafed insulation.

- Proper routing and connections.

- *Check electrical connectors for:*

- Corrosion on pins.

- Bent or damaged pins.

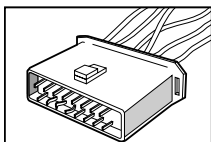

- Contacts not properly seated in housing.

- Bad wire crimps to terminals.

Problems with connectors are common in the engine control system. Inspect carefully. Note that some connectors use a special grease on the contacts to prevent corrosion. Do not wipe off! Obtain extra grease, if needed, from your vehicle dealer. It is a special type for this purpose.

Vehicle Preparation

Important: Complete ALL steps in this section before proceeding to Section 5, "Reading Trouble Codes." (Exception: Vehicles with Super Monitor Display – Do steps 1 through 6 only.)

1) Safety First!

- Set the parking brake.
- Put the shift lever in **PARK** or **Neutral**.
- Block the drive wheels.
- Make sure the ignition key is in the **OFF** position.

2) Vehicle Engine Must be at Normal Operating Temperature.

- Start engine and let idle until upper radiator hose is **HOT** and pressurized and RPM has settled to warm engine idle speed.

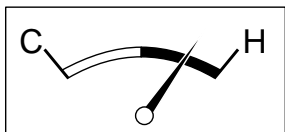

Warning: Always operate vehicle in well ventilated area. Exhaust gases are very poisonous! Observe all safety precautions (see page 2).

- Turn ignition key to OFF position.

3) Verify: Vehicle Battery Voltage is 11 Volts, or More.

Note that battery voltage will probably be O.K. (above 11 volts) unless you have had one of the following conditions:

- *Charging system failure.* Is the red "**CHARGE**" light (may be labeled with a small battery picture) illuminated on the instrument panel while the engine is running? If you have a voltage gauge on your instrument panel, is it indicating low voltage while the engine is running?
- *Battery sulfation.* Internal chemical damage (sulfation) may occur if the battery has been sitting for several months without having been charged.

- *Extensive battery use without the engine running.* Low battery voltage may be caused by long periods of cranking a no-start engine or having electrical accessories (lights, radio) on for more than 1/2 hour.

Correct any problems in these areas before proceeding.

4) Verify: Throttle is Fully Closed.

Make sure the accelerator pedal is not being held open by a fast idle cam (carbureted engines only), driver foot pressure, or any other means.

5) Verify: Transmission is in PARK or Neutral.

6) Verify: All Electrical Systems and Accessories are Turned OFF.

Also turn off vehicle air conditioner, if present.

7) Test the "CHECK" Engine Light

(Also called "**CHECK ENGINE**", or labeled with a small engine picture.)



- Turn the ignition key from the **OFF** to the **ON** position, **but do not start the engine!**
- Verify that the light turns **ON**.
- If the light does not turn on, you have a problem with this circuit which must be repaired before proceeding. Refer to the vehicle service manual. Some publications have this information in books or sections called "Computer-

ized Engine Controls”, “Electronic Engine Controls” or “Tune-Up Information.”

- Turn the ignition key **OFF**.

8) Find the Computer Test Connector

Referred to as the “**CHECK**” connector, the “**CHECK ENGINE**” connector, the “**ENGINE CHECK**” connector, the “**EFI**” connector, or the “**SERVICE**” connector.

There are 2 types...

- Circular plastic:

This is usually bright yellow (or green), with 2 contacts. It is located in the engine compartment. The

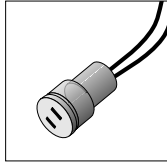

connector may be taped to the vehicle harness and fitted with a protective rubber cap, *or* plugged into a protective rubber cap mounted on a chassis part (such as an inner fender). This style connector is found primarily on 1983 through most 1986 model year vehicles, and vans through 1989.

- Rectangular plastic:

This is usually black or gray, with 18 or 24 contacts. The connector has a hinged cover

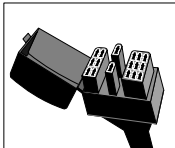

labeled “**DIAGNOSIS**”, “**DIAGNOSTIC**”, “**CHECK CONN**”, or similar. The connector is bracket mounted in various locations such as:

- inner fender
- fender wheel well
- strut or shock tower
- behind battery or near power distribution center (relay/fuse box)
- near ignition coil or air flow meter
- near wiper motor
- under driver’s seat (Previa)

9) Select the Proper Tool

- The **black** jumper wire is used with the circular type test connector.



- The code scanner tool is used with the rectangular type test connector.



10) Have a Pencil and Paper Ready

This is for writing down all the codes.

This completes the vehicle preparation.

Proceed to Section 5, “Reading Trouble Codes.”

Reading Codes

Important: Complete ALL steps in Section 4, "Vehicle Preparation" before reading trouble codes.

Toyota uses various computerized engine control systems.

- Trouble codes are read by counting flashes on the "CHECK" engine light (or using the Super Monitor Display).
- Use the chart below to find the code reading test procedure for your vehicle.

* Vehicle must have Super Monitor Display

Year	Usage	System	Test Pg.
1983	Camry, Celica, Starlet	EFI	12
1984	Camry, Celica, Starlet, Truck, Van	EFI	12
1985	Camry, Van	EFI	12
	Celica, Corolla (RWD), MR2, Pickup, 4Runner	TCCS-E	14
	Cressida*, Supra*	TCCS-M	20
1986	Camry, Celica w/2S-E Engine, Corolla, (RWD), MR2, Pickup, Van, 4Runner	TCCS-E	14
	Celica w/3S-GE Engine	TCCS-L	17
	Cressida*, Supra*	TCCS-M	20
1987	Corolla GT-S (RWD) & FX-16 (FWD), MR2, Pickup, Van, 4Runner	TCCS-E	14
	Camry, Celica	TCCS-L	17
	Cressida*, Supra*	TCCS-M	20
1988	4Runner, Pickup w/Turbocharged Engine	TCCS-E	14
	Camry, Celica, Corolla, Land Cruiser, MR2, Van, Pickup w/out Turbocharged Engine	TCCS-L	17
	Cressida*, Supra*	TCCS-M	20
1989 & newer	All models	TCCS-L	17

EFI Electronic Fuel Injection system

TCCS-E Toyota Computer Control System (Early version)

TCCS-L Toyota Computer Control System (Later version)

TCCS-M TCCS system with Super Monitor Display option

RWD = Rear Wheel Drive

FWD = Front Wheel Drive

EFI System

(Electronic Fuel Injection system)

1) Complete ALL steps in Section 4, "Vehicle Preparation"

2) Access Computer Test Connector

Rectangular type:

- Open hinged cover on connector.
- Some connectors use a special grease on the contacts to prevent corrosion. Do not wipe off!

Circular type:

- Remove the protective rubber cap from the connector.

3) Turn ignition Key to ON Position but DO NOT START THE ENGINE

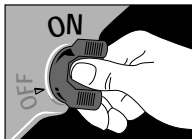

4) Install Code Scanning Tool

Rectangular test connector:

- Plug code scanner tool into connector.

Note: Tool does not completely cover all contacts in 24 pin type connector. This is normal.

- The tool only fits ONE WAY into the test connector
- The tool will *not* harm the vehicle engine computer.

Remove cap if present

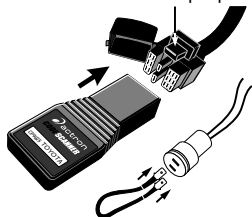

Circular test connector:

- Plug the **black** jumper wire into both test connector contacts.
- The jumper wire will *not* harm the vehicle engine computer.

5) Get Codes from the Flashing "CHECK" Engine Light

- Count flashes to get trouble codes.
- Only **single digit** codes (1 through 8) are used.
 - There is a 1 second pause between flashes.

Example: code 3 looks like...



FLASH (1 sec. pause) **FLASH** (1 sec. pause) **FLASH**

- There is a 3 second pause between codes.
- After all codes are sent, the whole sequence is repeated. This continues until the ignition key is turned OFF or the code scanning tool is disconnected.

Note: This means a code 1 (system O.K.) will appear as a single flash occurring every 3 seconds.

- Codes are sent in numeric order from the lowest number to the highest.

Example of code 3 only:



FLASH - FLASH - FLASH

(3 second pause, then start over again)

Example of code series 3 and 5:



FLASH - FLASH - FLASH

(3 second pause)



FLASH - FLASH - FLASH - FLASH - FLASH

(3 second pause, then start all over from the very beginning)

- After all trouble codes have been written down, finish testing as follows:

6) Turn ignition key OFF

7) Remove Tool from Connector and Replace Connector's Protective Cover

- The engine computer is now back to normal.

TEST RESULTS	COMMENTS
No indication on "CHECK" engine light	You have a problem with the diagnostic circuit which needs repair before using the code scanner tools. Refer to vehicle service manual.
Code 1 only	Computer does NOT find a problem. If drive symptom persists, be sure to perform a thorough underhood inspection first. (Refer to page 7.) Then refer to vehicle service manual for troubleshooting suggestions.
Any code(s)	Computer found problems in vehicle. Refer to "Toyota Code Meanings", page 22.

What to do with the Trouble Codes

Look up the code definitions listed in "Toyota Code Meanings."

At this point you can either:

- Have your vehicle professionally serviced. Trouble codes indicate problems found by the computer.
or,
- Repair the vehicle yourself using trouble codes to help pinpoint the problem. Refer to Section 3, "Using Codes." Be sure to erase any trouble codes from the computer's memory after repairs are completed, as indicated below.

Erasing Trouble Codes after Repair

- Disconnect the link or remove the indicated fuse for a minimum of 30 seconds.
 - *Camry*: Remove the "ECU +B" 15 amp fuse from the fuse block.

– *Celica, & Truck*: Remove the "STOP" 15 amp fuse from the fuse block.

– *Starlet*: Disconnect the fusible link (YELLOW connector) near the positive (+) battery terminal.

– *Van*: Remove the "EFI" 15 amp fuse from the fuse block.

- All the trouble codes are now erased from computer memory!
- Replace fuse or link. You may have to reset the vehicle clock, radio stations, and so on.

Important: The computer has a "learning" ability to take care of minor variations in engine control operation. Whenever you erase the computer memory, the computer has to "relearn" various things. Vehicle performance may be noticeably different until it "relearns". This temporary situation is normal. The "learning" process takes place during warm engine driving.

TCCS-E

(Toyota Computer Control System - Early version)

1) Complete ALL steps in Section 4, "Vehicle Preparation"

2) Access Computer Test Connector

Rectangular type:

- Open hinged cover on connector.
- Some connectors use a special grease on the contacts to prevent corrosion. Do not wipe off!

Circular type:

- Remove the protective rubber cap from the connector.

3) Turn ignition Key to ON Position but DO NOT START THE ENGINE

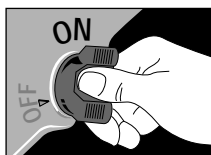

4) Install Code Scanning Tool

Rectangular test connector:

- Plug code scanner tool into connector.

Note: Tool does not completely cover all contacts in 24 pin type connector. This is normal.

- The tool only fits ONE WAY into the test connector
- The tool will *not* harm the vehicle engine computer.

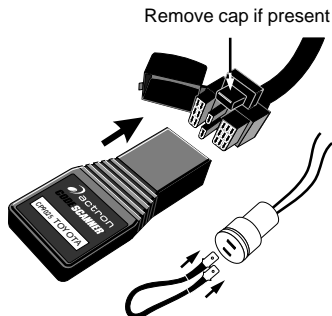

Circular test connector:

- Plug the **black** jumper wire into both test connector contacts. (Service manuals refer to these as the "T" and "E" terminals.)
- The jumper wire will *not* harm the vehicle engine computer.

5) Get Codes from the Flashing "CHECK" Engine Light

- Count flashes to get trouble codes.
- Only codes 1 through 14 are used.
 - There is a 1 second pause between flashes.

Example: code 3 looks like...



FLASH (1 sec. pause) **FLASH** (1 sec. pause) **FLASH**

- Two digit codes are sent as one long group of flashes. That is, a code 10 would be 10 flashes in a row, a code 12 would be 12 flashes in a row, and so on.
- There is a 4.5 second pause between codes.
- After all codes are sent, the whole sequence is repeated. This continues until the ignition key is turned OFF or the code scanning tool is disconnected.

Note: This means a code 1 (system O.K.) will appear as a single flash occurring every 4.5 seconds.

- Codes are sent in numeric order from the lowest number to the highest.

Example of code 3 only:



FLASH - FLASH - FLASH

(4.5 second pause, then start over again)

Example of code series 3 and 5:



FLASH - FLASH - FLASH
(4.5 second pause)



FLASH - FLASH - FLASH - FLASH - FLASH
(4.5 second pause, then start all over from the very beginning)

- After all trouble codes have been written down, finish testing as follows:

6) Turn ignition key OFF

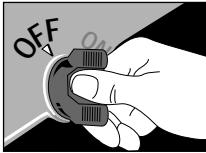

7) Remove Tool from Connector and Replace Connector's Protective Cover

- The engine computer is now back to normal.

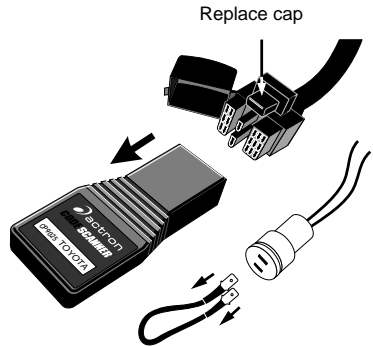

TEST RESULTS	COMMENTS
No indication on "CHECK" engine light	You have a problem with the diagnostic circuit which needs repair before using the code scanner tools. Refer to vehicle service manual.
Code 1 only	Computer does NOT find a problem. If drive symptom persists, be sure to perform a thorough underhood inspection first. (Refer to page 7) Then refer to vehicle service manual for troubleshooting suggestions.
Any code(s)	Computer found problems in vehicle. Refer to "Toyota Code Meanings", page 22.

What to do with the Trouble Codes

Look up the code definitions listed in "Toyota Code Meanings."

At this point you can either:

- Have your vehicle professionally serviced. Trouble codes indicate problems found by the computer.

or,

- Repair the vehicle yourself using trouble codes to help pinpoint the problem. Refer to Section 3, "Using Codes." Be sure to erase any trouble codes from the computer's memory after repairs are completed, as indicated on the following page.

Erasing Trouble Codes after Repair

- Remove the indicated fuse for a minimum of 30 seconds.

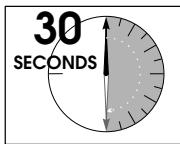
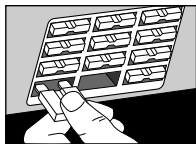

- *Corolla GT-S (RWD), 1985 Celica, MR2, 1986 MR2 & 1987 Corolla FX-16 (FWD):*

Remove the “**STOP**” 15 amp fuse from the fuse block.

- *1985 Corolla (RWD) & 1987 MR2:*

Remove the “**AM**₂” 7.5 amp fuse from the fuse block.

- *Camry, Celica, Pickup, Van, & 4Runner:*

Remove the “**EFI**” 15 amp fuse from the fuse block.

- All the trouble codes are now erased from computer memory!
- Replace fuse. You may have to reset the vehicle clock, radio stations, and so on.

Important: The computer has a “learning” ability to take care of minor variations in engine control operation. Whenever you erase the computer memory, the computer has to “relearn” various things. Vehicle performance may be noticeably different until it “relearns”. This temporary situation is normal. The “learning” process takes place during warm engine driving.

TCCS-L

(Toyota Computer Control System - Later version)

1) Complete ALL steps in Section 4, "Vehicle Preparation"

2) Access Computer Test Connector

Rectangular type:

- Open hinged cover on connector.
- Some connectors use a special grease on the contacts to prevent corrosion. Do not wipe off!

Circular type:

- Remove the protective rubber cap from the connector.

3) Turn ignition Key to ON Position but DO NOT START THE ENGINE.

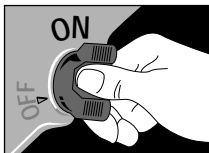

4) Install Code Scanning Tool

Rectangular test connector:

- Plug code scanner tool into connector.
Note: Tool does not completely cover all contacts in 24 pin type connector. This is normal.
- The tool only fits ONE WAY into the test connector
- The tool will *not* harm the vehicle engine computer.

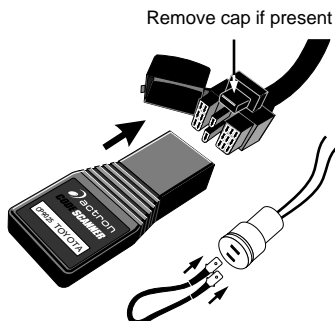

Circular test connector:

- Plug the **black** jumper wire into both test connector contacts. (Service manuals refer to these as the "T" and "E" terminals.)
- The jumper wire will *not* harm the vehicle engine computer.

5) Get Codes from the Flashing "CHECK" Engine Light

- **NOTE:** If no trouble codes are stored, the light will rapidly flash (about four times a second). This means the computer has found no problem.
- Count flashes to get trouble codes.
- All codes are 2 digits long.
- Each digit is a group of flashes.

Example: code 12 looks like...



FLASH (pause) **FLASH FLASH**

(FLASH = 1, FLASH FLASH = 2.)

Put 1 and 2 together = code 12.)

Example: code 23 looks like...



FLASH FLASH (pause) **FLASH FLASH FLASH**

- Codes are sent in numeric order from the lowest number to the highest.
- After all codes are sent, the whole sequence is repeated. This continues until the ignition key is turned OFF or the code scanning tool is disconnected.

Example of code series 11, 13 and 23:



FLASH (pause) FLASH
(2.5 second pause,
then go to next code)



FLASH (pause) FLASH FLASH FLASH
(2.5 second pause,
then go to next code)



FLASH FLASH (pause) FLASH FLASH FLASH
(4.5 second pause, then start all over
again from the very beginning)

Example of code 12 only:



FLASH (pause) FLASH FLASH
(4.5 second pause,
then start over again)

After all trouble codes have been written
down, finish testing as follows:

**6) Turn ignition
key OFF**

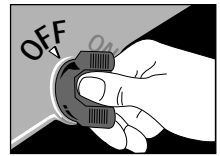

**7) Remove Tool
from Connector and Replace
Connector's Protective Cover**

- The engine computer is now back to normal.

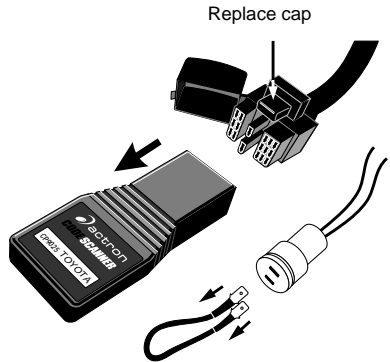

TEST RESULTS	COMMENTS
No indication on "CHECK" engine light	You have a problem with the diagnostic circuit which needs repair before using the code scanner tools. Refer to vehicle service manual.
Rapidly flashing "CHECK" engine light (About 4 times a second)	Computer does NOT find a problem. If drive symptom persists, be sure to perform a thorough underhood inspection first. (Refer to page7.) Then refer to vehicle service manual for troubleshooting suggestions.
Any code(s)	Computer found problems in vehicle. Refer to "Toyota Code Meanings", page 22.

What to do with the Trouble Codes

Look up the code definitions listed in "Toyota Code Meanings."

At this point you can either:

- Have your vehicle professionally serviced. Trouble codes indicate problems found by the computer.
or,
- Repair the vehicle yourself using trouble codes to help pinpoint the problem. Refer to Section 3, "Using Codes." Be sure to erase any trouble codes from the computer's memory after repairs are completed, as follows.

Erasing Trouble Codes after Repair

- Remove the indicated fuse for a minimum of 30 seconds.

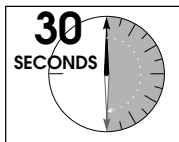
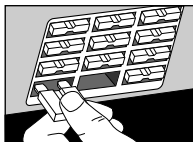

- *Camry, Celica, Cressida, Land Cruiser, 1991 & newer MR2, Paseo, Pickup, Previa, Supra, 1991 & newer Tercel, Van, & 4Runner:*

Remove the "EFI" fuse from the fuse block.

- *Corolla (ALL), & 1989, 1990 Tercel:*

Remove the "STOP" fuse from the fuse block.

- *1988, 1989 MR2:*

Remove the "AM₂" fuse from the fuse block.

- All the trouble codes are now erased from computer memory!
- Replace fuse. You may have to reset the vehicle clock, radio stations, and so on.

Important: The computer has a "learning" ability to take care of minor variations in engine control operation. Whenever you erase the computer memory, the computer has to "relearn" various things. Vehicle performance may be noticeably different until it "relearns". This temporary situation is normal. The "learning" process takes place during warm engine driving.

TCCS-M

(Toyota Computer Control System with Super Monitor Display option)

1) Complete Steps 1 Through 5 in Section 4, "Vehicle Preparation"

2) Turn ignition Key to ON Position but DO NOT START THE ENGINE

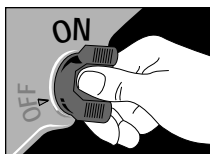

3) Have Pencil and Paper Ready

4) Press and Hold the "SELECT" and "INPUT M" Keys at the Same Time

- Press both keys for a minimum of **3 seconds**.

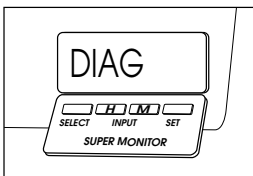

- The letters "DIAG" will appear on the Super Monitor's display.
- Wait a few seconds, then proceed to next step.

5) Press and Hold the "SET" Key for at Least 3 Seconds

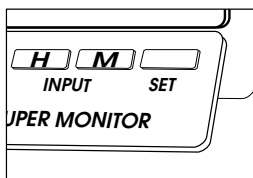

6) Read Trouble Codes on Display

- If there are **no** stored trouble codes, the display will show "E/G OK" or "ENG -OK".

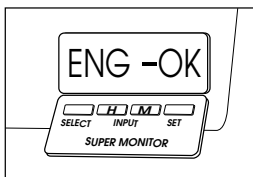

- Stored trouble codes are shown on display as follows...

Example of code 32: Display will show "E/G 32" or "ENG -32".

- All codes are 2 digits long.
- When more than 1 code is stored, there will be a **3 second** pause between codes.
- After all trouble codes have been written down, finish testing as follows:

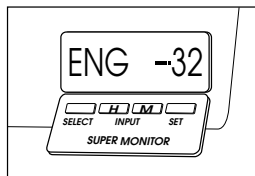

7) Press the "SELECT" Key to Show Time

8) Turn ignition key OFF

- The engine computer is now back to normal.

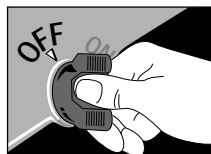

TEST RESULTS	COMMENTS
No indication on Super Monitor Display	You have a problem with the Super Monitor Display which needs repair before reading codes. Refer to vehicle service manual.
E/G OK or ENG-OK	Computer does NOT find a problem. If drive symptom persists, be sure to perform a thorough underhood inspection first. (Refer to page 7.) Then refer to vehicle service manual for troubleshooting suggestions.
Any code(s)	Computer found problems in vehicle. Refer to "Toyota Code Meanings.", page 22.

What to do with the Trouble Codes

Look up the code definitions listed in Section 6, "Toyota Code Meanings."

At this point you can either:

- Have your vehicle professionally serviced. Trouble codes indicate problems found by the computer.
- or,
- Repair the vehicle yourself using trouble codes to help pinpoint the problem. Refer to Section 3, "Using Codes." Be sure to erase any trouble codes from the computer's memory after repairs are completed, as follows.

Erasing Trouble Codes after Repair

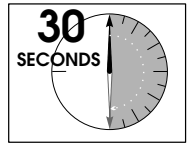
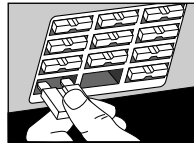

- On 1985 & 1986 vehicles:
Remove the "STOP" 15 amp fuse from the fuse block for a minimum of 30 seconds.
- On 1987 & 1988 vehicles:
Remove the "EFI" 15 amp fuse from the fuse block for a minimum of 30 seconds.

- All the trouble codes are now erased from computer memory!
- Replace fuse. You may have to reset the vehicle clock, radio stations, and so on.

Important: The computer has a "learning" ability to take care of minor variations in engine control operation. Whenever you erase the computer memory, the computer has to "relearn" various things. Vehicle performance may be noticeably different until it "relearns". This temporary situation is normal. The "learning" process takes place during warm engine driving.

Code Meanings

Note:

- Code meanings can vary with vehicle, model year, engine type and options.
- If a code number has more than one definition listed, note that **only one** definition applies to **your** vehicle. Consult service manual to get the specific definition for your vehicle.
- Each code definition includes a list of possible causes for the code.
- Follow vehicle service manual procedures to find the cause of the code.

Remember:

- 1) Visual inspections are important!
- 2) Problems with wiring and connectors are common, especially for intermittent faults.
- 3) Mechanical problems (vacuum leaks, binding or sticking linkages, etc.) can make a good sensor send an incorrect signal to the computer. This can cause a Trouble Code.
- 4) Incorrect information from a sensor may cause the computer to control the engine in the wrong way. Faulty engine operation might even make the computer show a different good sensor as being bad!

System	Pg. No.
EFI Codes	
Electronic Fuel Injection system	23
TCCS-E Codes	
Toyota Computer Control System (Early version)	24
TCCS-L Codes	
Toyota Computer Control System (Later version)	25
TCCS-M Codes	
TCCS system with Super Monitor Display option	25

EFI Codes

Electronic Fuel Injection system

1

System Normal -
No malfunction.

2

Airflow meter (AFM) signal
- Bad Airflow meter, Main relay, EFI Main relay, or associated meter/relay wiring.

3

Airflow meter (AFM) - Bad Airflow meter or meter wiring.

4

Coolant Temperature sensor signal - Bad Water (Coolant) Temperature sensor, Main relay or associated sensor/relay wiring.

5

Oxygen (O₂) sensor signal
- Air suction into Exhaust system. Leak in Air Induction system or Air Intake system. Bad or fouled Spark Plug(s). Bad Vacuum sensor, O₂ sensor(s), O₂ sensor Heater, Integrated Ignition Assembly (IIA), Air Flow meter, Fuel Injector(s), Cold Start Injector or Cam Position sensor. Improper Fuel pressure. Faulty Ignition system, Distributor. Wiring associated with these parts.

6

Ignition signal - Bad Ignition coil, Battery, Ignition switch, Neutral/start switch or Integrated Ignition Assembly (IIA). Missing

Starter (STA) signal. Loss of signal from Distributor to ECU. Faulty Distributor, Ignition System components. Wiring associated with these parts.

7

Throttle Position Sensor (TPS) signal - Bad Throttle Position sensor, Main relay, Electronic Fuel Injection (EFI) Main relay, or faulty sensor/relay wiring.

8

Intake Air Temperature sensor signal - Bad Air Temperature sensor, Air Flow meter, Main relay or faulty sensor/meter/relay wiring.

TCCS-E Codes

Toyota Computer Control System (Early version)

- 1**
System Normal - No malfunction.
- 2**
Airflow meter (AFM) signal - Bad Airflow meter, Main relay, EFI Main relay, or faulty meter/relay wiring.
- 3**
Ignition signal - Bad Igniter, Ignition coil, Ignition switch, Cam Position sensor, Ignition Main relay, Integrated Ignition Assembly (IIA), Cam Position sensor or Distributor. Wiring associated with these parts.
- 4**
Coolant Temperature sensor signal - Bad Water (Coolant) Temperature sensor, Main relay or faulty sensor/relay wiring.
- 5**
Oxygen (O₂) sensor signal - Air suction into Exhaust system. Leak in Air Induction system or Air Intake system. Bad or fouled Spark Plug(s). Bad Vacuum sensor, O₂ sensor(s), O₂ sensor Heater, Integrated Ignition Assembly (IIA), Air Flow meter, Fuel Injector(s), Cold Start Injector or Cam Position sensor. Improper Fuel pressure. Faulty Ignition system or Distributor. Wiring associated with these parts.
- 6**
RPM signal - Bad Igniter, Ignition Coil, Ignition switch, Cam Position sensor, Ignition Main relay, Integrated Ignition Assembly (IIA), Cam position sensor or Distributor. Wiring associated with these parts.
- 7**
Throttle Position Sensor (TPS) signal - Bad Throttle Position sensor, Main relay, Electronic Fuel Injection (EFI) Main relay, or faulty sensor/relay wiring.
- 8**
Intake Air Temperature sensor signal - Bad Air Temperature sensor, Air Flow meter, Main relay or faulty sensor/meter/relay wiring.
- 10**
Starter signal - Bad Starter, Battery, Ignition switch, Clutch switch, Clutch Start switch, Clutch Starter relay, Starter relay, Main relay, Neutral/Start switch or faulty wiring associated with these parts.
- 11**
Electronic Control Unit (ECU) Power supply (B+) - Bad Electronic Fuel Injection (EFI) relay, EFI Main relay, Main relay, Ignition switch or faulty relay/switch wiring.
or,
Switch signal - Bad Air Conditioning (A/C) switch, A/C Amplifier, Neutral/Start switch, Throttle Position sensor, Accelerator pedal or Accelerator Pedal cable. Faulty Throttle Position sensor IDL circuit. Wiring associated with these parts.
or,
Main Relay & circuit - Bad Main relay, Electronic Fuel Injection (EFI) Main relay, Ignition switch or faulty relay/switch wiring.
- 12**
RPM signal - Bad Cam Position sensor, Igniter, Ignition coil, Battery, Ignition switch, Clutch start switch, Neutral start switch, Starter relay or Integrated Ignition Assembly (IIA). Missing Starter (STA) signal. Loss of signal from Distributor to ECU. Faulty Distributor or Ignition system components. Wiring associated with these parts.
or,
- Knock sensor signal** - Bad Knock sensor or faulty sensor wiring.
- 13**
RPM signal - Bad Cam Position sensor, Igniter, Ignition coil, Battery, Ignition switch, Clutch start switch, Neutral start switch, Starter relay or Integrated Ignition Assembly (IIA). Missing Starter (STA) signal. Loss of signal from Distributor to ECU or faulty Distributor. Faulty Ignition system components. Wiring associated with these parts.
or,
Knock sensor Control - Bad Knock sensor control (ECU) or faulty sensor wiring.
- 14**
Ignition signal - Bad Igniter, Ignition Coil, Ignition switch, Cam Position sensor, Ignition Main relay, Main relay, Integrated Ignition Assembly (IIA), Cam position sensor or Distributor. Wiring associated with these parts.
or,
RPM signal - Bad Cam Position sensor, Igniter, Ignition switch or Integrated Ignition Assembly (IIA). Faulty Distributor. Wiring associated with these parts.
or,
Turbo Pressure - Bad Air Flow meter. Faulty Turbocharger. Wiring associated with these parts.
or,
Igniter & circuit - Bad Igniter or Ignition switch. Faulty Distributor. Wiring associated with these parts.

TCCS-L Codes

Toyota Computer Control System (Later version)

and

TCCS-M Codes

Toyota Computer Control System with Super Monitor Display option

11

Electronic Control Unit (ECU) Power supply (B+) - Bad Electronic Fuel Injection (EFI) relay, EFI Main relay, Main relay, Ignition switch or faulty relay/switch wiring.

or,

Main Relay & circuit - Bad Main relay, Electronic Fuel Injection (EFI) Main relay, Ignition switch or faulty relay/switch wiring.

12

RPM signal - Bad Cam Position sensor, Igniter, Ignition coil, Battery, Ignition switch, Clutch start switch, Neutral start switch, Starter relay or Integrated Ignition Assembly (IIA). Missing Starter (STA) signal. Loss of signal from Distributor to ECU. Faulty Distributor or Ignition system components. Wiring associated with these parts.

13

RPM signal - Bad Cam Position sensor, Igniter, Ignition coil, Battery, Ignition switch, Clutch start switch, Neutral start switch, Starter relay or Integrated Ignition Assembly (IIA). Missing Starter (STA) signal. Loss of signal from Distributor to ECU or faulty Distributor. Faulty Ignition system components. Wiring associated with these parts.

14

Ignition signal - Bad Igniter, Ignition Coil, Ignition switch, Cam Position sensor, Ignition Main relay, Main relay, Integrated Ignition Assembly (IIA) or Cam position sensor. Faulty Distributor. Wiring associated with these parts.

or,

RPM signal - Bad Cam Position sensor, Igniter, Ignition switch or Integrated Ignition Assembly (IIA). Faulty Distributor. Wiring associated with these parts.

or,

Igniter & circuit - Bad Igniter or Ignition switch. Faulty Distributor. Wiring associated with these parts.

16

Electronic Controlled Transaxle (ECT) system - Bad ECT program (in ECU).

21

Main Oxygen (O₂) sensor signal - Leak in Air Induction system. Bad Spark Plugs, Fuel Injector(s), Cold Start Injector, Air Flow meter, O₂ sensor or O₂ sensor Heater. Improper Fuel pressure. Faulty Distributor or Ignition system. Wiring associated with these parts.

or,

Oxygen (O₂) sensor signal - Air suction into Exhaust system. Leak in Air Induction system or Air Intake system. Bad Spark Plug(s), Vacuum sensor, O₂ sensor(s), O₂ sensor Heater Integrated Ignition Assembly (IIA), Air Flow meter, Fuel Injector(s), Cold Start Injector or Cam Position sensor. Improper Fuel pressure. Faulty Ignition system or Distributor. Wiring associated with these parts.

or,

Oxygen (O₂) sensor No.1 signal - Air suction into Exhaust system. Air Intake system leak. Bad Spark Plug(s), Vacuum sensor, O₂ sensor(s) or O₂ sensor Heater, Integrated Ignition Assembly (IIA), Air Flow meter, Fuel Injector(s) or

Cold Start Injector. Improper Fuel pressure. Faulty Ignition system or Distributor. Wiring associated with these parts.

22

Coolant Temperature sensor signal - Bad Water (Coolant) Temperature sensor or faulty sensor wiring.

or,

Coolant Temperature Switch signal - Bad Water (Coolant) Temperature switch(s) or faulty switch wiring.

23

Throttle Position sensor signal - Bad Throttle Position sensor or faulty sensor wiring.

or,

Intake Air Temperature sensor - Bad Intake Air Temperature sensor, Main relay or faulty sensor/relay wiring.

24

Intake Air Temperature sensor signal - Bad Air Temperature sensor, Air Flow meter or faulty sensor/meter wiring.

or,

Air Temperature sensor circuit - Bad Air Temperature sensor, Air Flow meter or faulty sensor/meter wiring.

25

Lean Air/Fuel mixture - Bad or blocked Fuel Injector(s). Bad Coolant Temperature sensor, Air Flow meter, Vacuum sensor, Electronic Air Bleed Control Valve (EBCV), Electronic Air Control Valve (EACV) or O₂ sensor. Improper Fuel line pressure. Faulty Carburetor,

Injector circuit, Ignition system, Air Intake system, Exhaust Gas Recirculation (EGR) system, EGR Vacuum lines or Engine ground.

Wiring associated with these parts.

or,

Oxygen (O₂) sensor circuit

- Bad or blocked Fuel Injector(s). Leak in Air Induction system. Bad Air Flow meter, O₂ sensor or Spark Plug(s). Improper Fuel line pressure. Faulty Ignition system or Distributor. Wiring associated with these parts.

26

Rich Air/Fuel mixture - Bad or leaking Fuel Injector(s) or Cold Start Injector. Bad Coolant Temperature sensor, Air Flow meter, Vacuum sensor, Electronic Air Bleed Control Valve (EBCV) or O₂ sensor. Improper Fuel line pressure or Compression pressure. Short in Injector circuit. Faulty Ignition system, Carburetor or Engine ground. Wiring associated with these parts.

or,

Oxygen (O₂) sensor circuit

- Bad or blocked Fuel Injector(s). Bad Air Flow meter, O₂ sensor, Cold Start Injector or Spark Plugs. Improper Fuel line pressure. Leak in Air Induction system. Faulty Injector circuit, Ignition system, Distributor or Air Induction system. Wiring associated with these parts.

27

Oxygen (O₂) sensor signal - Air suction into Exhaust system. Leak in Air Induction system or in Air Intake system. Bad Spark Plug(s), Vacuum sensor, O₂ sensor(s), O₂ sensor Heater, Air Flow meter, Cam Position sensor, Integrated Ignition Assembly (IIA), Fuel Injector(s) or Cold Start Injector. Improper Fuel line pressure. Faulty Ignition system or Distributor. Wiring associated with these parts.

or,

Sub Oxygen (O₂) sensor

signal - Air suction into Exhaust system, Leak in Air Induction system or in Air intake system. Bad Spark Plug(s), Vacuum sensor, O₂ sensor(s) or O₂ sensor Heater, Integrated Ignition Assembly (IIA), Air Flow meter, Fuel Injector(s) or Cold Start Injector. Improper Fuel line pressure. Faulty Ignition system or Distributor. Wiring associated with these parts.

28

Main Oxygen (O₂) sensor signal - Air suction into Exhaust system. Leak in Air Intake system. Bad Spark Plug(s) Vacuum sensor, O₂ sensor(s), O₂ sensor Heater, Air Flow meter, Fuel Injector(s) or Cold Start Injector. Improper Fuel line pressure. Faulty Ignition system or Distributor. Wiring associated with these parts.

or,

Oxygen sensor No. 2

signal - Air suction into Exhaust system. Leak in Air Induction system or in Air Intake system. Bad Spark Plug(s), Vacuum sensor, O₂ sensor(s), O₂ sensor Heater, Integrated Ignition Assembly (IIA), Air Flow meter, Fuel Injector(s), Cold Start Injector or Cam Position sensor. Improper Fuel line pressure. Faulty Distributor or Ignition system. Wiring associated with these parts.

31

Vacuum sensor signal - Bad Vacuum sensor or faulty sensor wiring.

or,

Vacuum switch signal - Bad Vacuum switch(s). Bad or out of adjustment Throttle Position (TPS) switch. Faulty Vacuum line(s) or switch/sensor wiring.

or,

Airflow meter signal - Bad Airflow meter, Main relay or faulty meter/relay wiring.

32

Airflow meter signal - Bad Airflow meter or faulty meter wiring.

or,

High Altitude Compensator (HAC) - Bad HAC or faulty circuit.

34

Turbocharger Pressure sensor - Bad Turbocharger Pressure sensor or Airflow meter. Faulty Intercooler system, Turbocharger or sensor/meter wiring.

35

Turbocharger Pressure sensor - Bad Turbocharger Pressure sensor or faulty sensor wiring.

or,

High Altitude Compensator (HAC) - Bad HAC or faulty circuit.

41

Throttle Position sensor (TPS) signal - Bad Throttle Position sensor, Main relay, EFI Main relay or faulty sensor/relay wiring.

or,

Throttle Position switch (TPS) signal - Bad or out of adjustment Throttle Position switch or faulty switch wiring.

42

Vehicle Speed sensor signal - Bad Vehicle Speed sensor, No.1 Speed Sensor or faulty sensor wiring.

43

Starter signal - Bad Starter, Battery, Ignition switch, Clutch switch, Clutch Start switch, Clutch Starter relay, Neutral Start switch, Starter relay or Main relay. Wiring associated with these parts.

51

Switch Condition - Bad Air Conditioning (A/C) switch, A/C Amplifier, Neutral/Start switch, Throttle Position sensor, Accelerator pedal or Accelerator pedal cable. Wiring associated with these parts.

or,

Switch signal - Bad Air Conditioning (A/C) switch or A/C Amplifier, Neutral/Start switch, Throttle Position sensor, Accelerator pedal or Accelerator Pedal cable. Wiring associated with these parts.

or,

Air Conditioning (A/C) signal - Bad A/C Amplifier or faulty amplifier wiring.

52

Knock sensor signal - Bad Knock sensor or faulty sensor wiring.

53

Knock sensor Control - Faulty Knock sensor control (ECU) or associated wiring.

or,

Knock Control - Faulty Knock control (ECU) or associated wiring.

54

Intercooler ECU Signal - Improper Intercooler Coolant level. Bad Intercooler Water pump or Coolant level sensor. Faulty Intercooler ECU. Wiring associated with these parts.

55

Knock sensor - Bad Knock sensor or sensor wiring.

71

Exhaust Gas Recirculation (EGR) system - Bad EGR Gas Temperature sensor or EGR Valve. Faulty EGR hose(s), EGR system or faulty sensor/EGR wiring.

72

Fuel Cut solenoid signal - Bad Fuel Cut solenoid or faulty solenoid wiring.

Vehicle Preparation

Complete ALL steps in this section before proceeding to “Reading Trouble Codes.”

IMPORTANT: Reading trouble codes on 1985 - 1990 (all models) and 1991 Civic, CRX, & Prelude models, requires access to the engine computer. **Due to varying mounting locations and methods, some mechanical disassembly may be required!** Refer to the Computer Location table in step 3 below. If you are unfamiliar or uncomfortable with the disassembly required, you may want to get help from another person before proceeding.

1) Safety First!

- Set the parking brake.
- Put the shift lever in **PARK** or **Neutral**.
- Block the drive wheels.
- Make sure all accessories are turned **OFF**
- Make sure the ignition key is in the **OFF** position.

2) Test the “PGM-FI” Light

(Also called “**CHECK**”, with a small engine picture, or “PGM-CARB”.)



- Turn the ignition key from the **OFF** to the **ON** position, **but do not start the engine!**
- Verify that the light turns **ON** for **2 seconds**.
- If the light does not turn on, you have a problem with this circuit which should be repaired. Refer to the vehicle service manual. Some publications have this information in books or sections called “Computerized Engine Controls”, “Electronic Engine Controls” or “Tune-Up Information.”
- Turn the ignition key **OFF**.

IMPORTANT:

- **1985-1990 (all models) and 1991 Civic, CRX, Prelude:** Go to step 3.
- **All other models:** Go to step 5.

3) Locate the Engine Computer

Note: Honda refers to the engine computer as the **ECU** (Electronic Control Unit).

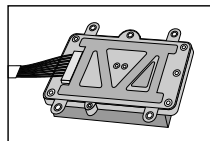

Accord, 1985 - 1990
Under driver’s seat

Accord, 1991 - 1992
Under front passenger’s footwell (beneath the carpeting, below the dashboard)

Civic, 1988 - 1991
Under front passenger’s footwell (beneath the carpeting, below the dashboard)

Civic, 1992
Behind front passenger’s kick panel (right of passenger’s right foot)

Civic Si 1986 - 1987
Under front passenger seat

Civic CRX Si, 1985-1987
Under front passenger seat

Civic CRX Si, 1988
Under front passenger’s footwell (beneath the carpeting, below the dashboard)

CRX, 1989 - 1991
Under front passenger’s footwell (beneath the carpeting, below the dashboard)

Prelude, 1986 - 1987
Behind left (driver’s) side rear seat trim panel

Prelude, 1988 - 1992
Under front passenger’s footwell (beneath the carpeting, below the dashboard)

4) Access the Computer for Testing

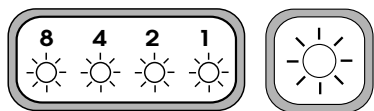

- Trouble codes are “read” by noting which LED’s are “ON” (4 LED system) or by observing the flash pattern of a single LED (1 LED system). These LED’s are mounted inside the computer. They can be seen through a “sight window” (an opening in the computer housing) or reflected by a small mirror in some cases.
- Remove any vehicle parts such as kick panels or other plastic pieces which would restrict access to the LED sight window. Carefully turn back the carpeting if necessary.
- The computer itself may have to be removed from its mounting location.
 - *Make note of wire harness position before moving computer. Harness should be replaced in original position when computer remounted.*
 - **Do not disconnect any of the wiring harness connectors which plug into the computer. You may lose stored trouble codes!**

5) Have pencil, and paper on hand

- These are for writing down all the codes.

This completes the vehicle preparation.

Proceed to “Reading Trouble Codes”, page 30.

Reading Codes

Important: Complete ALL steps in “Vehicle Preparation” before reading trouble codes.

- Honda uses various computerized engine control systems.
- Trouble codes are read by:
 - Observing LED’s (Light Emitting Diodes) built into the engine computer
OR...
 - Counting flashes on the “CHECK” engine light.
- Use the chart below to find the code reading test procedure for your vehicle.

Remember: Vehicles using the instrument panel (“CHECK” engine) lamp for reading trouble codes do NOT require engine computer access.

Year	Usage	System	Test Pg.
1985	Accord SEi, Civic CRX Si	4 LED	32
1986	Accord LXi, Prelude (all)	1 LED	34
	Civic CRX Si, Civic Si	4 LED	32
1987	Accord LXi, Prelude (all)	1 LED	34
	Civic CRX Si, Civic Si	4 LED	32
1988	Accord LXi, Civic (all), Civic CRX Si, Prelude (all)	1 LED	34
1989	Accord LXi, Civic (all), CRX, Prelude (all)	1 LED	34
1990	Accord (all), Civic (all), CRX, Prelude (all)	1 LED	34
1991	Accord (all)	panel lamp	37
	Civic (all), CRX, Prelude (all except 2.1 Liter)	1 LED	34
	Prelude with 2.1 Liter	1 LED	37
1992	All models	panel lamp	37

SPECIAL NOTE:

Vehicles With Electronically Controlled Automatic Transaxles

- Some vehicles have computer controlled automatic transaxles (transmissions).
- Typically these transmissions are self-diagnosing, similar to the engine control systems covered in this section.
- Note that certain engine control system failures may also cause the "S", "D", or "D₄" transmission indicator lamp to flash along with the "CHECK" Engine lamp. Should this happen during the trouble code reading procedures described later, repair the engine control system trouble codes first.
- After engine control system repair, clear the automatic transaxle computer's memory by removing the appropriate fuse for 15 seconds.
- Test drive the vehicle, then re-check the engine control system for trouble codes. In many cases, once the engine control system failure is repaired, the transaxle trouble code will also disappear.
- If the transaxle trouble code is not eliminated, then proceed with a self-diagnostic check on the automatic transaxle as outlined in the vehicle service manual.

1985 Accord SEi, Civic CRX Si

1986 Civic CRX Si, Civic Si

1987 Civic CRX Si, Civic Si

Preliminary Checks

Honda service manuals list several checks which should be made before reading trouble codes. Problems in the areas listed below can cause the computer to set false or misleading codes. Ignoring these checks can make you miss the real cause of a code! This can lead to the unnecessary replacement of good parts. Service manual procedures for troubleshooting a code assume all preliminary checks are good. These checks vary with vehicle. Typical checks are listed below. Refer to service manual for your vehicle requirements.

- Visually inspect electrical wiring & connectors.
- Visually inspect vacuum hoses & connectors.
- Perform a compression test.
- Perform an exhaust system backpressure test.
- Perform a fuel pressure test.
- Check curb idle speed.
- Check ignition timing.

1) **Make sure the engine computer LED display is easily viewable.**

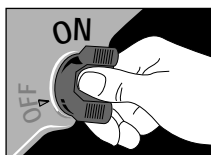

2) **Have your pencil and paper ready.**

3) Turn the ignition switch ON, but DO NOT START THE ENGINE.

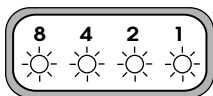

4) **Get code numbers from the LED display.**



 = ON
 = OFF

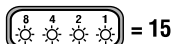

= 15

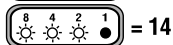

= 14

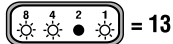

= 13

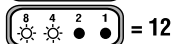

= 12

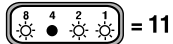

= 11



= 10

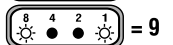

= 9



= 8

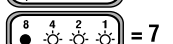

= 7

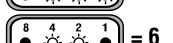

= 6

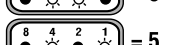

= 5

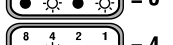

= 4



= 3



= 2



= 1



= 0

Each LED has a numeric value.

• The *left* LED has a value of 8.

• The next LED in line has a value of 4.

• The next LED in line has a value of 2.

• The *right* LED has a value of 1.

Add values of the lighted LED's to get the Trouble Code. (Off LED's have a value of zero.)

Example of code zero:

No LED's are lit, indicating a code zero ("0").

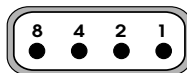

Example of code 2:

LED 2 is lit, indicating a code 2.

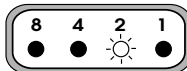

Example of code 10:

LED's 8 and 2 are lit, indicating a code 10. (8 + 2 = 10)

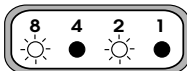

- Trouble codes from zero (no LED's lit) through 15 (all LED's lit) are used.
- When more than one code is stored:
 - Each trouble code is presented once.
 - There is a **2 second pause** between codes.

5) Write down all displayed Trouble Codes.

6) To view codes a second time, turn the ignition key **OFF** and then back to the **ON** position.

7) This completes trouble code retrieval on these vehicles. Turn the ignition key **OFF**. (The engine computer is back to normal operation.)

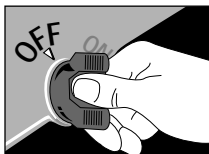

What to do with the Trouble Codes

Look up the code definitions listed in Section 9, "Honda Code Meanings."

At this point you can either:

- Have your vehicle professionally serviced. Trouble codes indicate problems found by the computer.
- or,*
- Repair the vehicle yourself using trouble codes to help pinpoint the problem. Refer to Section 3, "Using Codes." Be sure to erase any trouble codes from the computer's memory after repairs are completed, as follows.

Erasing Trouble Codes After Repair

- Verify that the ignition key is in the OFF position.
- Remove the negative (-) battery cable and wait 15 seconds.
- All the trouble codes are now erased from computer memory!
- Reconnect battery cable. You may have to reset the vehicle clock, radio stations, and so on.

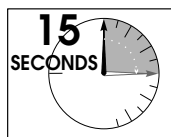
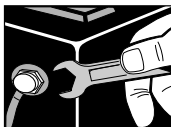

Important: The computer has a "learning" ability to take care of minor variations in engine control operation. Whenever you erase the computer memory, the computer has to "relearn" various things. Vehicle performance may be noticeably different until it "relearns". This temporary situation is normal. The "learning" process takes place during warm engine driving.

- 1986 Accord LXi, Prelude (Fuel Injected only)
- 1987 Accord LXi, Prelude (Fuel Injected only)
- 1988 All models except carbureted Accord
- 1989 All models except carbureted Accord
- 1990 All models
- 1991 All models except Accord (any) and Prelude with 2.1 Liter engine

Preliminary Checks

Honda service manuals list several checks which should be made before reading trouble codes. Problems in the areas listed below can cause the computer to set false or misleading codes. Ignoring these checks can make you miss the real cause of a code! This can lead to the unnecessary replacement of good parts. Service manual procedures for troubleshooting a code assume all preliminary checks are good. These checks vary with vehicle. Typical checks are listed below. Refer to service manual for your vehicle requirements.

- Visually inspect electrical wiring & connectors.
- Visually inspect vacuum hoses & connectors.
- Perform a compression test.
- Perform an exhaust system backpressure test.
- Perform a fuel pressure test.
- Check curb idle speed.
- Check ignition timing.

1) Make sure the engine computer LED is easily viewable.

2) Have your pencil and paper ready.

3) Turn the ignition key ON, but DO NOT START THE ENGINE.

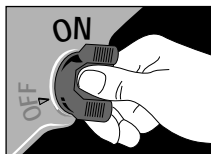

4) Get codes from the flashing LED.

- The LED blinks long flashes and short flashes.
 - The duration of the LONG flash is 2 seconds.



- The duration of the SHORT flash is 1 second.



For codes 1 through 10...

- Count SHORT flashes to get the code.

Example of code 4:



For codes 11 through 99...

- Count LONG flashes to get the first digit.
- Count SHORT flashes to get the second digit.
- Combine digits to get the code.

Example of code 12:



The pause between the first and second digits is 2 seconds.

Remember:

- If SHORT flashes come first, the code is 10, or less.
- If LONG flashes come first, it is the first digit of a two digit code.

The pause between codes is 2 seconds.

Multiple Codes...

- Depending upon system, trouble codes are repeated 2 or 3 times in succession.

Example: Code 12

Sent as...



PAUSE



or



PAUSE



PAUSE



- Several different codes can be stored if the computer sees more than one problem.
- Some systems group codes based on occurrence:

Example: Codes 13 and 21 occur at different times.

(Codes have unrelated causes.)

Sent as...



PAUSE



PAUSE



PAUSE



Notice how each code is repeated before the next code is sent.

Example: Codes 13 and 21 occur at same time.

(Same failure may have caused both codes.)

Sent as...



PAUSE



PAUSE



PAUSE



--Notice how the codes are grouped and the code group is repeated.

NOTE: Some early fuel injected models (typically 1986 & 1987) may use short flashes for displaying *all* codes. The flashes are 1 second long with a 2 second pause between codes. Both single and 2 digit codes are sent as one long series of flashes. For example, a trouble code 13 would be displayed as 13 consecutive short flashes (instead of 1 long and 3 short flashes).

5) Write down all displayed Trouble Codes.

6) To view codes a second time, turn the ignition key OFF and then back to the ON position.

7) This completes trouble code retrieval on these vehicles. Turn the ignition key OFF. (The engine computer is back to normal operation.)



What to do with the Trouble Codes

Look up the code definitions listed in Section 9, "Honda Code Meanings."

At this point you can either:

- Have your vehicle professionally serviced. Trouble codes indicate problems found by the computer.
or,
- Repair the vehicle yourself using trouble codes to help pinpoint the problem. Refer to Section 3, "Using Codes." Be sure to erase any trouble codes from the computer's memory after repairs are completed, as follows.

Erasing Trouble Codes after Repair

- Verify that the ignition key is in the OFF position.



- Remove the negative (-) battery cable or indicated fuse and wait 15 seconds.

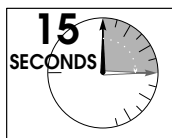
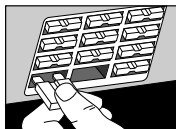
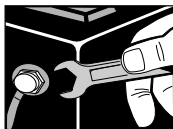

- 1986 to 1987 ALL:
Remove the **negative (-) battery cable**.
- 1988 to 1989 Accord LXi:
Remove the **CLOCK Fuse, # 11**.
- 1988 to 1990 Civic, & CRX:
Remove the **HAZARD Fuse, # 34**.
- 1988 to 1990 Prelude (CARB):
Remove the **EFI/ECU Fuse, # 38**.
- 1988 to 1991 Prelude (INJ):
Remove the **CLOCK Fuse, # 35**.
- 1990 Accord:
Remove the **BACKUP Fuse, # 24**.
- 1991 Civic, CRX:
Remove the **ECU Fuse, # 34**.
- All the trouble codes are now erased from computer memory!
- Replace fuse or reconnect battery cable. You may have to reset the vehicle clock, radio stations, and so on.

Important: The computer has a "learning" ability to take care of minor variations in engine control operation. Whenever you erase the computer memory, the computer has to "relearn" various things. Vehicle performance may be noticeably different until it "relearns". This temporary situation is normal. The "learning" process takes place during warm engine driving.

1991 Accord (all)
1991 Prelude with 2.1L engine
1992 All models

Preliminary Checks

Honda service manuals list several checks which should be made before reading trouble codes. Problems in the areas listed below can cause the computer to set false or misleading codes. Ignoring these checks can make you miss the real cause of a code! This can lead to the unnecessary replacement of good parts. Service manual procedures for troubleshooting a code assume all preliminary checks are good.

These checks vary with vehicle. Typical checks are listed below. Refer to service manual for your vehicle requirements.

- Visually inspect electrical wiring & connectors.
- Visually inspect vacuum hoses & connectors.
- Perform a compression test.
- Perform an exhaust system backpressure test.
- Perform a fuel pressure test.
- Check curb idle speed.
- Check ignition timing.

- 1) Make sure the ignition key is in the OFF position.



- 2) Access the Service Check Connector.

This 2-contact rectangular connector is usually light blue and is located as follows:

Accord, 1991-1992

Above the Front Passenger's Kick Panel (right of passenger's right foot) close to the door.

Civic, 1992

Behind the Front Passenger's Kick Panel (right of passenger's right foot).

Prelude, 1991 (with 2.1L engine)

Under the hood, on the left fender, to the rear of the Fuse/Relay Block. This connector will likely have a protective cover over the terminals.

Prelude, 1992

Behind the center console, in front of the accelerator pedal.

Note: Search carefully for the Service Check connector. It may be tucked away among vehicle harnessing

- 3) Install the **WHITE** jumper wire in the Service Check Connector.

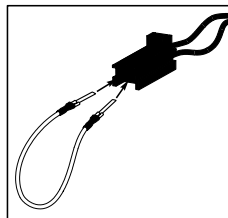

- 4) Have your pencil and paper ready.

- 5) Turn the ignition key ON, but DO NOT START THE ENGINE.

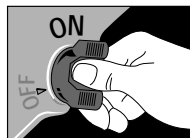

- 6) All except 1991 Prelude with 2.1L engine:

Get codes from the flashing "CHECK" engine light.

1991 Prelude with 2.1L engine ONLY:

Get codes from the flashing LED. (Engine computer must be accessed.)

- The light blinks long flashes and short flashes.

–The duration of the LONG flash is 2 seconds.



–The duration of the SHORT flash is 1 second.



For codes 1 through 10...

– Count SHORT flashes to get the code.

Example of code 4:



For codes 11 through 99...

– Count LONG flashes to get the first digit.

– Count SHORT flashes to get the second digit.

– Combine digits to get the code.

Example of code 12:



The pause between the first and second digits is 2 seconds.

Remember:

– If SHORT flashes come first, the code is 10, or less.

– If LONG flashes come first, it is the first digit of a two digit code.

The pause between codes is 2 seconds.

Multiple Codes...

• Depending upon system, trouble codes are repeated 2 or 3 times in succession.

Example: Code 12

Sent as...



PAUSE



or



PAUSE



PAUSE



• Several different codes can be stored

if the computer sees more than one problem.

- Some systems group codes based on occurrence:

Example: Codes 13 and 21 occur at different times.

(Codes have unrelated causes.)

Sent as...

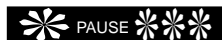

PAUSE



PAUSE



PAUSE



Notice how each code is repeated before the next code is sent.

Example: Codes 13 and 21 occur at same time.

(Same failure may have caused both codes.)

Sent as...

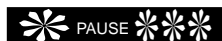

PAUSE



PAUSE

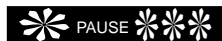

PAUSE



--Notice how the codes are grouped and the code group is repeated.

7) Write down all displayed Trouble Codes.

8) To view codes a second time, turn the ignition key OFF and then back to the ON position.

9) Turn the ignition key OFF and remove the WHITE jumper wire. (The engine computer is back to normal operation.)

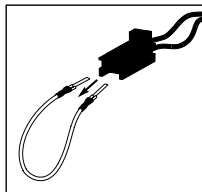

Erasing Trouble Codes after Repair

• Verify that the ignition key is in the OFF position.



• Remove the indicated fuse from the fuse block and wait 15 seconds.

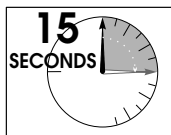
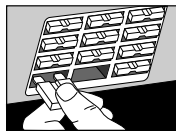
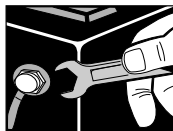

10) This completes trouble code retrieval on these vehicles. Return the Service Check Connector to its original location. Reinstall any parts such as moldings, kick panels or other plastic pieces which may have been removed to access the the Service Check Connector.

What to do with the Trouble Codes

Look up the code definitions listed in Section 9, "Honda Code Meanings."

At this point you can either:

- Have your vehicle professionally serviced. Trouble codes indicate problems found by the computer.
or,
- Repair the vehicle yourself using trouble codes to help pinpoint the problem. Refer to Section 3, "Using Codes." Be sure to erase any trouble codes from the computer's memory after repairs are completed, as follows.

- 1991 & 1992 Accord:
Remove the **BACKUP Fuse, # 24.**
- 1992 Civic:
Remove the **BACKUP Fuse, # 32.**
- 1991 Prelude with 2.1L engine:
Remove the **CLOCK Fuse, # 35.**
- 1992 Prelude:
Remove the **CLOCK/RADIO Fuse, # 34.**
- All the trouble codes are now erased from computer memory!
- Replace fuse. You may have to reset the vehicle clock, radio stations, and so on.

Important: The computer has a "learning" ability to take care of minor variations in engine control operation. Whenever you erase the computer memory, the computer has to "relearn" various things. Vehicle performance may be noticeably different until it "relearns". This temporary situation is normal. The "learning" process takes place during warm engine driving.

Code Meanings

Note:

- Code meanings can vary with vehicle, model year, engine type and options.
- If a code number has more than one definition listed, note that **only one** definition applies to **your** vehicle. Consult service manual to get the specific definition for your vehicle.
- Each code definition includes a list of possible causes for the code.
- Follow vehicle service manual procedures to find the cause of the code.

Remember:

- 1) Visual inspections are important!
- 2) Problems with wiring and connectors are common, especially for intermittent faults.
- 3) Mechanical problems (vacuum leaks, binding or sticking linkages, etc.) can make a good sensor send an incorrect signal to the computer. This can cause a Trouble Code.
- 4) Incorrect information from a sensor may cause the computer to control the engine in the wrong way. Faulty engine operation might even make the computer show a different good sensor as being bad!

0 (zero)

(Check Engine Light may be ON or OFF.)

Bad power or ground connection to Electronic Control Unit (ECU). Faulty ECU Fuse. Short circuit in combination meter or Check Engine light bulb wiring. Bad ECU. Problems with Manifold Absolute Pressure (MAP) sensor, Throttle angle (Position) sensor, Atmospheric (PA) sensor, Idle Mixture Adjuster sensor or Exhaust Gas Recirculation (EGR) valve lift sensor. Faulty Automatic Transmission (A/T) control unit or Main relay. No signal to ECU.

1

Oxygen (O₂) sensor - Bad Oxygen sensor or faulty sensor wiring.

or,

Pressure regulator - Bad Pressure regulator, faulty associated wiring or improper fuel pressure.

or,

Spark Plug mis-fire

2

Oxygen (O₂) sensor - Bad Oxygen sensor or faulty sensor wiring.

or,

Vehicle Speed Sensor (VSS) - Bad Vehicle Speed sensor, faulty sensor wiring, Vacuum leaks or improper Fuel pressure.

or,

Electronic Control Unit (ECU) - Bad ECU or faulty ECU wiring.

3

Manifold Absolute Pressure (MAP) sensor - Bad MAP sensor or faulty sensor wiring.

4

Top Dead Center/Crank/Cylinder (TDC/CRANK/CYL) sensors - Bad TDC/CRANK/CYL sensor or faulty sensor wiring.

or,

TDC/Crank sensor - Bad TDC/Crank sensor or faulty sensor wiring

or,

Crank Angle sensor - Bad Crank Angle sensor or faulty sensor wiring.

or,

Pulse Generator assembly - Bad Pulse Generator assembly or faulty pulse generator wiring.

or,

Vacuum Switch - Bad Vacuum switch or Manifold Absolute Pressure (MAP) sensor. Faulty switch/sensor wiring or Vacuum lines.

or,

Electronic Control Unit (ECU) - Bad ECU or faulty ECU wiring.

5

Manifold Absolute Pressure (MAP) sensor - Bad MAP sensor or restriction in throttle body. Faulty Vacuum hose or sensor wiring.

6

Coolant Temperature (TW) sensor - Bad Coolant Temperature sensor. Faulty Automatic Transmission (A/T) control unit or sensor/control unit wiring.

7

Throttle Angle (position) sensor - Bad Throttle Angle (position) sensor. Faulty Automatic Transmission (A/T) control unit or sensor/control unit wiring.

or,

Clutch Switch Signal Manual Transmission (M/T) - Bad Clutch Switch Control unit or faulty control unit wiring.

or,

Automatic Transmission (A/T) Shift Position Signal - Faulty control unit or control unit wiring.

8

Top Dead Center (TDC) sensor - Bad TDC sensor or faulty sensor wiring.

or,

Pulse generator - Bad Pulse generator or faulty wiring.

or,

Ignition Output Signal - Bad Ignition coil or faulty ignition wiring.

or,

CYL sensor - Bad CYL sensor or faulty sensor wiring.

or,

TDC/Crank sensor - Bad TDC/Crank sensor or faulty sensor wiring.

or,

Crank Angle sensor - Bad Crank Angle sensor. Faulty sensor wiring or Crank Angle sensor wiring near Spark Plug wires.

9

NO.1 Cylinder (CYL) sensor - Bad NO. 1 CYL sensor or faulty sensor wiring.

or,

CYL sensor - Bad CYL sensor assembly or faulty sensor wiring.

or,

TDC/Crank/CYL sensor - Bad TDC/Crank/CYL sensor or faulty sensor wiring.

or,

CRK/CYL sensor - Bad CRK/CYL sensor or faulty sensor wiring.

or,

Crank Angle sensor - Bad Crank Angle sensor. Faulty sensor wiring or Crank Angle sensor wiring near Spark Plug wires.

10

Air Temperature (TA) sensor - Bad Air Temperature sensor or faulty sensor wiring.

or,

Intake Air Temperature (TA) sensor - Bad Intake Air Temperature sensor or faulty sensor wiring.

11

Idle Mixture Adjuster (IMA) sensor - Bad IMA sensor or faulty sensor wiring.

12

Exhaust Gas Recirculation (EGR) system - Blocked EGR passages. Bad EGR valve, EGR Control Solenoid valve, Constant Vacuum Control (CVC) valve, (EGR) Solenoid Control valve, EGR Control solenoid, EGR Control Lift sensor, EGR solenoid, EGR Valve Lift sensor or EGR Lift sensor. Improper Vacuum hose routing. Faulty Vacuum hose(s). Wiring associated with these parts.

13

Atmospheric Pressure (PA) sensor - Bad PA sensor or faulty sensor wiring.

14

Electronic Air Control valve (EACV) - Bad EACV or faulty EACV wiring.

or,

Idle Control System (EACV) - Bad EACV or faulty EACV wiring.

or,

Electronic Control Unit (ECU) - Bad ECU or faulty ECU wiring.

15

Ignition Output Signal - Bad Igniter unit, Ignition coil or faulty ignition wiring.

NOTE:

- If engine will not start, crank for 20 seconds to reproduce codes.
- Igniter may be damaged due to short in wire to ECU. If no code is stored, Check Engine Light may stay ON while service connector is jumped.

or,

Electronic Control Unit (ECU) - Bad ECU or faulty ECU wiring.

16

Fuel Injector circuit - Bad Fuel Injector, Fuel Injector resistor, Main Relay or faulty associated wiring.

17

Vehicle Speed Sensor (VSS) - Bad VSS or faulty sensor wiring.

or,

Vehicle Speed Pulsar (VSS) - Bad VSS. Faulty Automatic Transmission (A/T) control unit or sensor/control unit wiring.

19

Lock-up Control solenoid - Bad Lock-up solenoid, Lock-up Solenoid Valve or faulty solenoid wiring.

20

Electrical Load Detector (ELD) - Bad ELD or faulty ELD wiring.

or,

Electric Load detector (ELD) - Bad ELD or faulty ELD wiring.

21

Variable Valve Timing Electronic Control (VTEC) Spool Valve - Bad VTEC Spool valve or faulty valve wiring.

22

Variable Valve Timing Electronic Control (VTEC) Oil Pressure switch - Bad VTEC Oil Pressure switch, VTEC Spool Valve or faulty switch/valve wiring.

23

Knock sensor - Bad Knock sensor or faulty sensor wiring.

30

Automatic Transmission (A/T) "A" signal - Faulty signal wiring.

or,

A/T FI Signal A - Faulty signal wiring.

31

Automatic Transmission (A/T) "B" signal - Faulty signal wiring.

or,

A/T FI Signal B - Faulty signal wiring.

41

Oxygen (O₂) sensor heater - Bad Oxygen sensor or faulty sensor wiring.

or,

Linear Air/Fuel Ratio (LAF) sensor - Bad LAF sensor or faulty sensor wiring.

43

Fuel Supply system - Bad Oxygen (O₂) sensor or problem in fuel system.

48

Linear Air/Fuel Ratio (LAF) sensor - Bad LAF sensor or faulty sensor wiring.

Vehicle Preparation

Complete ALL steps in this section before proceeding to “Reading Trouble Codes,” page 46

IMPORTANT: Reading trouble codes on Nissan vehicles requires access to the engine computer. **Due to varying mounting locations and methods, some mechanical disassembly may be required!** Refer to the Computer Location table in step 3 (see page 44). If you are unfamiliar or uncomfortable with the disassembly required, you may want to get help from another person before proceeding.

1) Safety First!

- Set the parking brake.
- Put the shift lever in **PARK** or **Neutral**.
- Block the drive wheels.
- Make sure all accessories are turned **OFF**.
- Make sure the ignition key is in the **OFF** position.



2) Test the “CHECK” Engine Light

(Also called “CHECK ENGINE”, or labeled with a small engine picture.)



NOTE: If vehicle does NOT have a “CHECK” engine light, go directly to step 3.

- Turn the ignition key from the **OFF** to the **ON** position, **but do not start the engine!**
- Verify that the light turns **ON**.
- If the light does not turn on, you have a problem with this circuit which must be repaired. Refer to the vehicle service manual. Some publications have this information in books or sections called “Computerized Engine Controls”, “Electronic Engine Controls” or “Tune-Up Information.”
- Turn the ignition key **OFF**.

3) Locate the Engine Computer

Note: Nissan refers to the engine computer as the **ECU** (Electronic Control Unit).

Vehicle Line		Computer Location
Axxess	1990	Under Dashboard, behind Center Console
Maxima	1985 - 1986	Under Left Side of Dashboard
	1987 - 1988	Under Front Passenger Seat
	1989 - 1992	Under Dashboard, behind Center Console
NX	1991 - 1992	Under Dashboard, behind Center Console
Pathfinder	ALL	Under Front Passenger Seat
Pickup	ALL	Under Front Passenger Seat
Pulsar	1987 - 1989	Under Front Passenger Seat
	1990	Between the Front Seats
Sentra	1987 - 1989	Under Front Passenger Seat
	1991 - 1992	Under Dashboard, behind Center Console
	2 WD 1990	Between the Front Seats
	4 WD 1990	Under Driver's Seat
Stanza	1984 - 1986	Behind Driver's Kick Panel (left of driver's left foot)
	1987 - 1989	Under Front Passenger Seat
	1990 - 1991	Under Center Console
	1992	Behind Center Console
Wagon	1987 - 1988	Under Driver's Seat
Van	1987	Under Front Passenger Seat
	1988	Next to Rear Seat on Driver's side, behind the left Kick Panel (left of left rear passenger's position)
	1990	On left side behind the Panel above the Vehicle's Battery
200SX	ALL	Behind Driver's Kick Panel (left of driver's left foot)
240SX	1989, 91 - 92	Behind Front Passenger's Kick Panel (right of passenger's right foot)
	1990	Under Right Side of Dashboard
300ZX	1984 - 1989	Behind Front Passenger's Kick Panel (right of passenger's right foot)
	1990	Center of Dashboard, Behind Console
	1991 - 1992	Behind the Glove Box

4) Access the Computer for Testing

- Trouble codes are “read” by observing the flash patterns of 1 or 2 LED’s (Light Emitting Diodes) mounted inside the computer. These LED’s can be seen through a “sight window” - an opening in the top or side of the computer housing.
- Also mounted in the computer is the test switch or potentiometer which must be operated to start the code reading process.
- Remove any vehicle parts such as kick panels or other plastic pieces which would restrict access to the LED sight window, the test switch or potentiometer.
- The computer itself may have to be removed from its mounting location.
 - Make note of wire harness position before moving computer. Harness should be replaced in original position when computer is re-mounted.
 - Do not disconnect any of the wiring harness connectors which plug into the computer. You may lose stored trouble codes!**



5) Have the Selector Tool on hand

This is for starting the code reading process.



6) Have a Pencil and Paper Ready

This is for writing down all the codes.

This completes the vehicle preparation.

Proceed to “Reading Trouble Codes,” page 46.

Reading Codes

Important: Complete ALL steps in “Vehicle Preparation” before reading trouble codes.

Nissan uses several engine computer systems and trouble code reading procedures.

- Trouble codes are obtained by counting LED (Light Emitting Diode) flashes.
- The LED's are built into the computer – there may be 1 or 2 LED's used.
- Refer to chart on next page for your vehicle.

1) Find the number of LED's used.

2) Read the procedure for counting flashes, page 48.

3) Follow the test procedure on the page listed in the chart.

The procedures assume you already know how to get codes from the LED flashes.

Vehicle computer systems listed for reference – referred to in service manuals.

EFI ECS Electronic Fuel Injection Electronic Control System.

ECCS Electronic Concentrated engine Control System.

ECCS-5 Electronic Concentrated engine Control System with 5 test modes.

ECCS-2 Electronic Concentrated engine Control System with 2 test modes.

Year	Usage	System	LED's	Test Pg.
1984	Stanza	EFI ECS	2	50
	200SX	EFI ECS	2	52
	200SX Turbo, 300ZX, 300ZX Turbo	ECCS	2	56
1985	Stanza, 200SX	EFI ECS	2	52
	200SX Turbo	ECCS	2	60
	Maxima, 300ZX, 300ZX Turbo	ECCS	2	58
1986	Stanza, 200SX	EFI ECS	2	54
	200SX Turbo	ECCS	2	60
	Maxima, 300ZX, 300ZX Turbo	ECCS	2	62
1986 1/2	Pickup	ECCS	2	64
1987	All models <u>except</u> Pathfinder, Pickup, Van	ECCS-5	2	66
	Pathfinder, Pickup, Van	ECCS-5	2	68
1988	All models <u>except</u> Pathfinder, Pickup, Van	ECCS-5	2	66
	Pathfinder, Pickup, Van	ECCS-5	2	68
1989	All models <u>except</u> Pathfinder, Pickup	ECCS-5	2	66
	Pathfinder, Pickup	ECCS-5	2	68
1990	All models (incl. Axxess) <u>except</u> Stanza, Van, 300ZX	ECCS-5	2	66
	Van (not Axxess)	ECCS-5	2	68
	Stanza, 300ZX	ECCS-2	1	70
1991	Maxima, Pathfinder, Pickup	ECCS-5	2	66
	NX, Sentra, Stanza, 240SX, 300ZX	ECCS-2	1	70
1992	Maxima with VG30E engine, Pathfinder, Pickup	ECCS-5	2	66
	Maxima with VE30DE (DIS) engine, NX, Sentra, Stanza, 240SX, 300ZX	ECCS-2	1	70

2 LED System

How to Count Flashes to get Trouble Codes

This system uses a RED and a GREEN LED.

- All Nissan trouble codes are 2 digits long.
 - Count RED flashes to get the first digit.
 - Count GREEN flashes to get the second digit.
 - Combine digits to get the code.

Example of code 12:



- The RED LED will flash first, followed by the GREEN LED.

Example of code sequence 12 and 32:

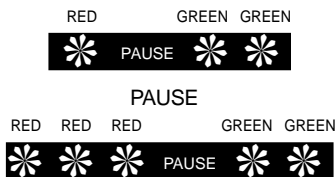

Note the **1 flash** of the RED LED then **2 flashes** of the GREEN LED (indicating a **code 12**) followed by a pause followed by **3 flashes** of the RED LED then **2 flashes** of the GREEN LED (indicating a **code 32**).

1 LED System

How to Count Flashes to get Trouble Codes

This system uses a single RED LED.

- The LED blinks long flashes and short flashes.
 - The duration of the LONG flash is .6 seconds.
 - The duration of the SHORT flash is .3 seconds.
- All Nissan trouble codes are 2 digits long.
 - Count LONG flashes to get the first digit.
 - Count SHORT flashes to get the second digit.
 - Combine digits to get the code.

Example of code 12:



- Look for the LONG flashes first, then the SHORT flashes when reading a code.

Example of code sequence 12 and 32:



Note the **1 long flash** of the LED then **2 short flashes** (indicating a **code 12**) followed by a long pause followed by **3 long flashes** of the LED then **2 short flashes** (indicating a **code 32**).

- The long pause between codes is 2.1 seconds.

Warning: Involves running engine. Observe all safety precautions (see page 2). Work in well ventilated area.

- 1) Use Selector tool or other means to turn the Diagnosis Mode Selector to the ON position.



- 2) Turn the ignition switch ON, but DO NOT START THE ENGINE.

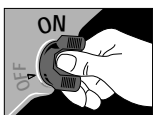

- 3) Check to see that both the RED and GREEN LED's turn ON and flash at the same time:

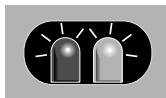

- If they do, proceed to the next step.
- If they do not, the computer (ECU) may be defective. Refer to vehicle service manual.

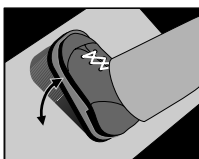

- 4) Depress and release accelerator pedal.

- 5) Turn the A/C switch from OFF to ON to OFF (if equipped).



- 6) Have your pencil and paper ready.

- 7) Observe the RED and GREEN LED's.

- Code 32 is normal at this point and may be ignored.
- Codes **other than 32** indicate a problem which should be repaired before proceeding.

- 8) When the results from Step 7 are satisfactory, start the engine and observe the RED and GREEN LED's.

- *Vehicles with air conditioning:* Code 44 indicates that the computer system is O.K. and that testing is complete. Codes **other than 44** indicate a problem which should be repaired.
- *Vehicles without air conditioning:* Code 31 indicates that the computer system is O.K. and that testing is complete. Codes **other than 31** indicate a problem which should be repaired.

- 9) When all diagnostic procedures are complete, turn the ignition switch to the OFF position, and the Diagnosis Mode Selector to the OFF position.



What to do with the Trouble Codes

Look up the code definitions listed in Section 12, "Nissan Code Meanings,"

At this point you can either:

- Have your vehicle professionally serviced. Trouble codes indicate problems found by the computer.
- or,*
- Repair the vehicle yourself using trouble codes to help pinpoint the problem. Refer to Section 3, "Using Codes." Be sure to erase any trouble codes from the computer's memory after repairs are completed, as indicated on the following page.

Erasing Trouble Codes After Repair

- 10) Turn the ignition switch OFF.

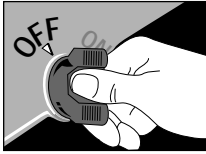

- 11) Disconnect the negative (-) battery cable.

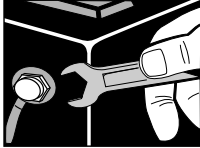

- 12) Remove the harness connector from the computer (ECU) and wait 15 seconds.

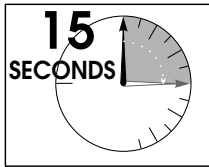

- 13) Reconnect the ECU's harness connector.

- 14) Reconnect the negative (-) battery cable. You may have to reset the vehicle clock, radio stations, etc.

Important: The computer has a "learning" ability to take care of minor variations in engine control operation. Whenever you erase the computer memory, the computer has to "relearn" various things. Vehicle performance may be noticeably different until it "relearns". This temporary situation is normal. The "learning" process takes place during warm engine driving.

NOTE: When reinstalling the ECU, be careful to route all wiring to its original position.

Trouble codes are now erased!

1984 - 85 200SX, 1985 Stanza

Warning: Involves running engine. Observe all safety precautions (see page 2). Work in well ventilated area.

- 1) Using the Selector Tool or other means, verify that the Diagnosis Mode Selector is in the OFF position.

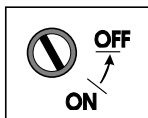

- 2) Turn the ignition switch ON, but DO NOT START THE ENGINE.



- 3) Check to see that both the RED and GREEN LED's turn ON and stay ON.

- If they do, proceed to the next step.
- If they do not, you have a problem with the battery supply circuit which feeds the computer (ECU), or the ECU itself may be defective. This failure must be repaired before proceeding. Refer to the vehicle service manual. Some publications have this information in books or sections called "Computerized Engine Controls", "Electronic Engine Controls", or "Tune-Up Information."



- 4) Turn the Diagnosis Mode Selector to the ON position.

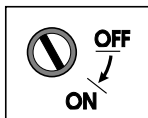

- 5) Have your pencil and paper ready.

- 6) Observe the RED and GREEN LED's.

- Codes 23, 24, and 31 should be displayed.
- Note any codes other than 23, 24, and 31.

- 7) Depress and release accelerator pedal.



- 8) Observe the RED and GREEN LED's.

- Codes 24, and 31 should be displayed.
- Note any codes other than 24, and 31.

- 9) Move the gear shift lever from Neutral to the highest gear and then back to Neutral.

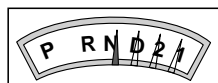

- 10) Observe the RED and GREEN LED's.

- Code 31 should be displayed.
- Note any codes other than 31.

- 11) Start the vehicle's engine.

- 12) Observe the RED and GREEN LED's.

- Code 31 should be displayed.
- Note any codes other than 31.

- 13) Turn the A/C switch from OFF to ON to OFF (if equipped).



- 14) Observe the RED and GREEN LED's.

- Code 44 should be displayed.
- Note any codes other than 44.

- 15) When all diagnostic procedures are complete, turn the Diagnosis Mode Selector to the OFF position, and the ignition switch to the OFF position.

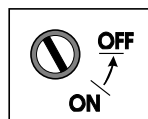

What to do with the Trouble Codes

Look up the code definitions listed in Section 12, "Nissan Code Meanings,"

At this point you can either:

- Have your vehicle professionally serviced. Trouble codes indicate problems found by the computer.
or,
- Repair the vehicle yourself using trouble codes to help pinpoint the problem. Refer to Section 3, "Using Codes." Be sure to erase any trouble codes from the computer's memory after repairs are completed, as follows:

Erasing Trouble Codes after Repair

16) Verify that the **Diagnosis Mode Selector** is in the **OFF** position.

17) Remove either the **harness connector from the computer (ECU), or the negative (-) battery cable and wait 15 seconds.**

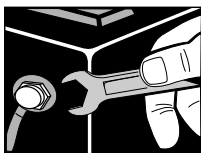

Trouble codes are now erased!

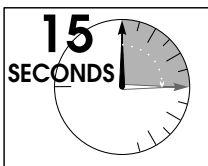

18) Reconnect the **ECU's harness connector, or the negative (-) battery cable. You may have to reset the vehicle clock, radio stations, and so on.**

Important: The computer has a "learning" ability to take care of minor variations in engine control operation. Whenever you erase the computer memory, the computer has to "relearn" various things. Vehicle performance may be noticeably different until it "relearns". This temporary situation is normal. The "learning" process takes place during warm engine driving.

NOTE: When reinstalling the ECU, be careful to route all wiring to its original position.

1986 Stanza, 200SX

Warning: Involves running engine. Observe all safety precautions (see page 2). Work in well ventilated area.

- 1) Using the Selector Tool or other means, verify that the Diagnosis Mode Selector is in the OFF position.

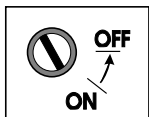

- 2) Turn the ignition switch ON, but do not start the engine.

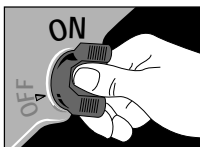

- 3) Check to see that both the RED and GREEN LED's turn ON and stay ON.



- If they do, proceed to the next step.
- If they do not, you have a problem with the battery supply circuit which feeds the computer (ECU), or the ECU itself may be defective. This failure must be repaired before proceeding. Refer to the vehicle service manual. Some publications have this information in books or sections called "Computerized Engine Controls", "Electronic Engine Controls", or "Tune-Up Information."

- 4) Turn the Diagnosis Mode Selector to the ON position.

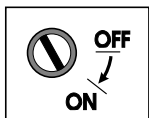

- 5) Have your pencil and paper ready.

- 6) Observe the RED and GREEN LED's.

- *Manual Transmission vehicles:* codes **23, 24, 31, and 32** should be displayed.
- Note any codes **other than 23, 24, 31, and 32.**

- *Automatic Transmission vehicles:* codes **31, and 32** should be displayed.

- Note any codes **other than 31, and 32.**

- 7) Depress and release accelerator pedal.

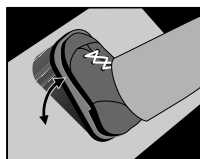

- 8) Observe the RED and GREEN LED's.

- Codes **24, 31, and 32** should be displayed.
- Note any codes **other than 24, 31, and 32.**

- 9) Move the gear shift lever from Neutral to the highest gear and then back to Neutral.

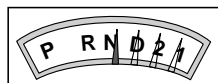

- 10) Observe the RED and GREEN LED's.

- Codes **31, and 32** should be displayed.
- Note any codes **other than 31, and 32.**

- 11) Start the vehicle's engine.

- 12) Observe the RED and GREEN LED's.

- Code **31** should be displayed.
- Note any codes **other than 31.**

- 13) Turn the A/C switch from OFF to ON to OFF (if equipped).



- 14) Observe the RED and GREEN LED's.

- Code **44** should be displayed.
- Note any codes **other than 44.**

- 15) When all diagnostic procedures are complete, turn the Diagnosis Mode Selector to the OFF position, and the ignition switch to the OFF position.

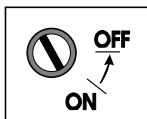

What to do with the Trouble Codes

Look up the code definitions listed in Section 12, "Nissan Code Meanings,"

At this point you can either:

- Have your vehicle professionally serviced. Trouble codes indicate problems found by the computer.
- or,
- Repair the vehicle yourself using trouble codes to help pinpoint the problem. Refer to Section 3, "Using Codes." Be sure to erase any trouble codes from the computer's memory after repairs are completed, as follows:

Erasing Trouble Codes after Repair

- 16) Verify that the Diagnosis Mode Selector is in the OFF position.

- 17) Remove either the harness connector from the computer (ECU), or the negative (-) battery cable and wait 15 seconds.

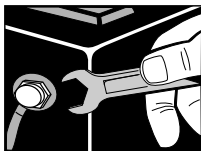

Trouble codes are now erased!

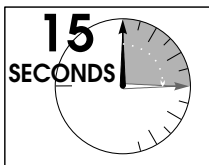

- 18) Reconnect the ECU's harness connector, or the negative (-) battery cable. You may have to reset the vehicle clock, radio stations, and so on.

Important: The computer has a "learning" ability to take care of minor variations in engine control operation. Whenever you erase the computer memory, the computer has to "relearn" various things. Vehicle performance may be noticeably different until it "relearns". This temporary situation is normal. The "learning" process takes place during warm engine driving.

NOTE: When reinstalling the ECU, be careful to route all wiring to its original position.

1984 200SX Turbo, 300ZX, 300ZX Turbo

Warning: Involves running engine. Observe all safety precautions (see page 2). Work in well ventilated area.

- 1) Mark the initial setting of the Diagnostic Mode Selector on the computer housing.

IMPORTANT: The Diagnostic Mode Selector is a potentiometer. It is critical that the initial position (setting) of this potentiometer be marked on the computer housing so that when testing is complete, it can be reset to its original position!

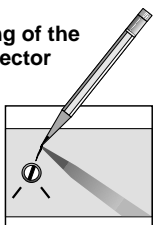

- 2) Using the Selector Tool or other means, turn the Diagnosis Mode Selector to the fully COUNTER-CLOCKWISE position.

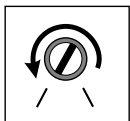

- 3) Turn the ignition switch ON, but do not start the engine.

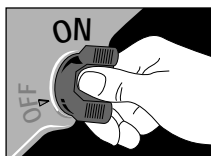

- 4) Check to see that both the RED and GREEN LED's turn ON and stay ON.



- If they do, proceed to the next step.
- If they do not, you have a problem with the battery supply circuit which feeds the computer (ECU), or the ECU itself is defective. This failure must be repaired before proceeding. Refer to the vehicle service manual. Some publications have this information in books or sections called "Computerized Engine Controls", "Electronic Engine Controls", or "Tune-Up Information."

- 5) Turn the Diagnosis Mode Selector fully CLOCKWISE.

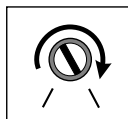

- 6) Have your pencil and paper ready.

- 7) Observe the RED and GREEN LED's.

- Codes 23, 24, (300ZX Turbo only) and 31 (all vehicles) should be displayed.
- Note any codes other than 23, 24, and 31.

- 8) Depress and release accelerator pedal.

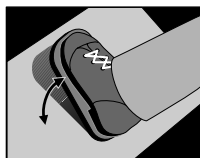

- 9) Observe the RED and GREEN LED's.

- Codes 24, (300ZX Turbo only) and 31 (all vehicles) should be displayed.
- Note any codes other than 24, and 31.

- 10) (For 300ZX Turbo only. All others go to Step 12). Move the gear shift lever from Neutral to the highest gear and then back to Neutral.

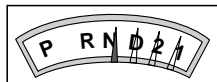

- 11) Observe the RED and GREEN LED's.

- Code 31 should be displayed.
- Note any codes other than 31.

- 12) Start the vehicle's engine.

- 13) Observe the RED and GREEN LED's.

- Codes 14, (300ZX Turbo only) and 31 (all vehicles) should be displayed.
- Note any codes other than 14, and 31.

14)(For 300ZX & 300ZX Turbo only. All others go to Step 16). Drive the vehicle at a speed of greater than 6 MPH. **Warning: Get the help of another person for this step!**

15)Observe the RED and GREEN LED's.

- Code 31 should be displayed.
- Note any codes **other than 31**.

16)Turn the A/C switch from OFF to ON to OFF (if equipped).



17)Observe the RED and GREEN LED's.

- Code 44 should be displayed.
- Note any codes **other than 44**.

18)When all diagnostic procedures are complete, turn the Diagnosis Mode Selector fully COUNTERCLOCKWISE, then the ignition switch to the OFF position.

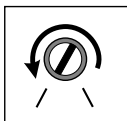

19)IMPORTANT: Turn the Diagnosis Mode Selector to its initial position (setting) as marked in Step 1 of the test procedure.

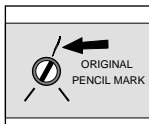

What to do with the Trouble Codes

Look up the code definitions listed in Section 12, "Nissan Code Meanings," At this point you can either:

- Have your vehicle professionally serviced. Trouble codes indicate problems found by the computer.
- or,
- Repair the vehicle yourself using trouble codes to help pinpoint the problem. Refer to Section 3, "Using Codes." Be sure to erase any trouble codes from the computer's memory after repairs are completed, as indicated below.

Erasing Trouble Codes after Repair

20)Turn the ignition switch to the ON position, but do not start the engine.

21)Turn the Diagnosis Mode Selector fully CLOCKWISE, and wait at least 3 seconds.

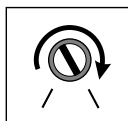

22)Turn the Diagnosis Mode Selector fully COUNTERCLOCKWISE, and wait at least 3 seconds.

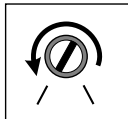

23)Turn the ignition switch to the OFF position.

Trouble Codes are now erased!

24)IMPORTANT: Turn the Diagnosis Mode Selector to its initial position (setting) as marked in Step 1 of the test procedure.

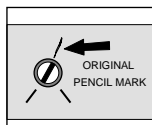

NOTE: When reinstalling the computer, be careful to route all wiring to its original position.

1985 Maxima, 300ZX, 300ZX Turbo

Warning: Involves running engine. Observe all safety precautions (see page 2). Work in well ventilated area.

- 1) Mark the initial setting of the Diagnostic Mode Selector on the computer housing.

IMPORTANT: *The Diagnostic Mode Selector is a potentiometer. It is critical that the initial position (setting) of this potentiometer be marked on the computer housing so that when testing is complete, it can be reset to its original position!*

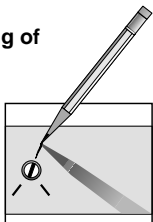

- 2) Using the Selector Tool or other means, turn the Diagnosis Mode Selector to the fully COUNTER-CLOCKWISE position.

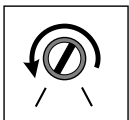

- 3) Turn the ignition switch ON, but do not start the engine.

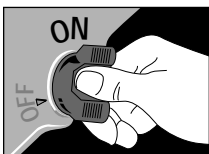

- 4) Check to see that both the RED and GREEN LED's turn ON and stay ON.



- If they do, proceed to the next step.
- If they do not, you have a problem with the battery supply circuit which feeds the computer (ECU), or the ECU itself is defective. This failure must be repaired before proceeding. Refer to the vehicle service manual. Some publications have this information in books or sections called "Computerized Engine Controls", "Electronic Engine Controls", or "Tune-Up Information."

- 5) Turn the Diagnosis Mode Selector fully CLOCKWISE.

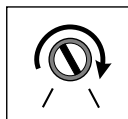

- 6) Have your pencil and paper ready.

- 7) Observe the RED and GREEN LED's.

- On the **300ZX Turbo** only, codes **23, 24, and 31** should be displayed.
- Note any codes **other than 23, 24, and 31**.
- On **all other models** codes **23, and 31** should be displayed.
- Note any codes **other than 23, and 31**.

- 8) Depress and release accelerator pedal.



- 9) Observe the RED and GREEN LED's.

- On the **300ZX Turbo** only, codes **24, and 31** should be displayed.
- Note any codes **other than 24, and 31**.
- On **all other models** code **31** should be displayed.
- Note any codes **other than 31**.

- 10)(For 300ZX Turbo only. All others go to Step 12).

Move the gear shift lever from Neutral to the highest gear and then back to Neutral.

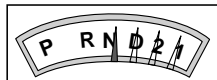

- 11) Observe the RED and GREEN LED's.

- Code **31** should be displayed.
- Note any codes **other than 31**.

12) Start the vehicle's engine.

13) Observe the RED and GREEN LED's.

- On the **300ZX Turbo** only, codes **14**, and **31** should be displayed.
- Note any codes **other than 14**, and **31**.
- On **all other models** code **31** should be displayed.
- Note any codes **other than 31**.

14) (For 300ZX and 300ZX Turbo only. If Maxima, go to Step 16). Drive the vehicle at a speed of greater than 6 MPH. Warning: Get the help of another person for this step!

15) Observe the RED and GREEN LED's.

- Code **31** should be displayed.
- Note any codes **other than 31**.

16) Apply the parking brake, and block the drive wheels. Move the gear shift lever to the DRIVE position. Turn the A/C switch from OFF to ON to OFF (if equipped).



17) Observe the RED and GREEN LED's.

- Code **44** should be displayed.
- Note any codes **other than 44**.

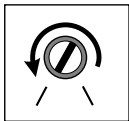

18) When all diagnostic procedures are complete, turn the Diagnosis Mode Selector fully COUNTERCLOCKWISE, then the ignition switch to the OFF position.

19) IMPORTANT: Turn the Diagnosis Mode Selector to its initial position (setting) as marked in Step 1 of the test procedure.

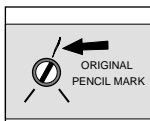

What to do with the Trouble Codes

Look up the code definitions listed in Section 12, "Nissan Code Meanings,"

At this point you can either:

- Have your vehicle professionally serviced. Trouble codes indicate problems found by the computer.
- or,
- Repair the vehicle yourself using trouble codes to help pinpoint the problem. Refer to Section 3, "Using Codes." Be sure to erase any trouble codes from the computer's memory after repairs are completed, as indicated below.

Erasing Trouble Codes after Repair

20) Turn the ignition switch to the ON position, but do not start the engine.

21) Turn the Diagnosis Mode Selector fully CLOCKWISE, and wait at least 3 seconds.

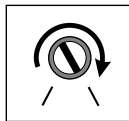

22) Turn the Diagnosis Mode Selector fully COUNTERCLOCKWISE, and wait at least 3 seconds.

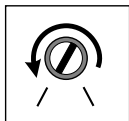

23) Turn the ignition switch to the OFF position.

Trouble Codes are now erased!

24) IMPORTANT: Turn the Diagnosis Mode Selector to its initial position (setting) as marked in Step 1 of the test procedure.

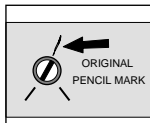

NOTE: When reinstalling the computer, be careful to route all wiring to its original position.

1985 - 1986 200SX Turbo

Warning: Involves running engine. Observe all safety precautions (see page 2). Work in well ventilated area.

- 1) Mark the initial setting of the Diagnostic Mode Selector on the computer housing.

IMPORTANT: The Diagnostic Mode Selector is a potentiometer. It is critical that the initial position (setting) of this potentiometer be marked on the computer housing so that when testing is complete, it can be reset to its original position!

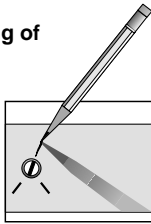

- 2) Using the Selector Tool or other means, turn the Diagnosis Mode Selector to the fully COUNTER-CLOCKWISE position.

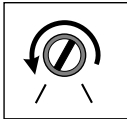

- 3) Turn the ignition switch ON, but do not start the engine.

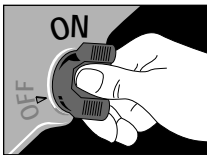

- 4) Check to see that both the RED and GREEN LED's turn ON and stay ON.



- If they do, proceed to the next step.
- If they do not, you have a problem with the battery supply circuit which feeds the computer (ECU), or the ECU itself is defective. This failure must be repaired before proceeding. Refer to the vehicle service manual. Some publications have this information in books or sections called "Computerized Engine Controls", "Electronic Engine Controls", or "Tune-Up Information."

- 5) Turn the Diagnosis Mode Selector fully CLOCKWISE.

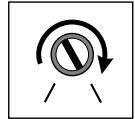

- 6) Have your pencil and paper ready.

- 7) Observe the RED and GREEN LED's.

- Codes 23, 31, and 32 should be displayed.
- Note any codes other than 23, 31, and 32.

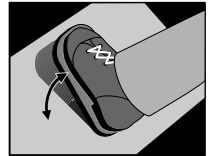

- 8) Depress and release accelerator pedal.

- 9) Observe the RED and GREEN LED's.

- Codes 31, and 32 should be displayed.
- Note any codes other than 31, and 32.

- 10) Start the vehicle's engine.

- 11) Observe the RED and GREEN LED's.

- Code 31 should be displayed.
- Note any codes other than 31.

- 12) Turn the A/C switch from OFF to ON to OFF (if equipped).



- 13) Observe the RED and GREEN LED's.

- Code 44 should be displayed.
- Note any codes other than 44.

- 14) When all diagnostic procedures are complete, turn the Diagnosis Mode Selector fully **COUNTERCLOCKWISE**, then the ignition switch to the **OFF** position.

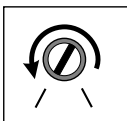

- 15) **IMPORTANT:** Turn the Diagnosis Mode Selector to its initial position (setting) as marked in Step 1 of the test procedure.

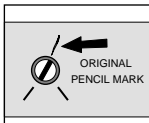

What to do with the Trouble Codes

Look up the code definitions listed in Section 12, "Nissan Code Meanings," At this point you can either:

- Have your vehicle professionally serviced. Trouble codes indicate problems found by the computer.
- or,
- Repair the vehicle yourself using trouble codes to help pinpoint the problem. Refer to Section 3, "Using Codes." Be sure to erase any trouble codes from the computer's memory after repairs are completed, as indicated below.

Erasing Trouble Codes after Repair

- 16) Turn the ignition switch to the **ON** position, but do not start the engine.

- 17) Turn the Diagnosis Mode Selector fully **CLOCKWISE**, and wait at least 3 seconds.

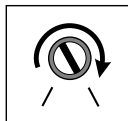

- 18) Turn the Diagnosis Mode Selector fully **COUNTERCLOCKWISE**, and wait at least 3 seconds.

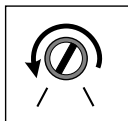

- 19) Turn the ignition switch to the **OFF** position.

Trouble Codes are now erased!

- 20) **IMPORTANT:** Turn the Diagnosis Mode Selector to its initial position (setting) as marked in Step 1 of the test procedure.

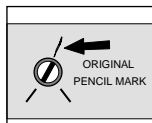

NOTE: When reinstalling the computer, be careful to route all wiring to its original position.

1986 Maxima, 300ZX, 300ZX Turbo

Warning: Involves running engine. Observe all safety precautions (see page 2). Work in well ventilated area.

- 1) Mark the initial setting of the Diagnostic Mode Selector on the computer housing.

IMPORTANT: *The Diagnostic Mode Selector is a potentiometer. It is critical that the initial position (setting) of this potentiometer be marked on the computer housing so that when testing is complete, it can be reset to its original position!*

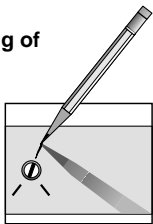

- 2) Using the Selector Tool or other means, turn the Diagnosis Mode Selector to the fully COUNTERCLOCKWISE position.

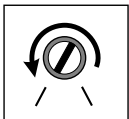

- 3) Turn the ignition switch ON, but do not start the engine.

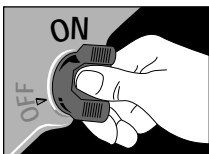

- 4) Check to see that both the RED and GREEN LED's turn ON and stay ON.



- If they do, proceed to the next step.
- If they do not, you have a problem with the battery supply circuit which feeds the computer (ECU), or the ECU itself is defective. This failure must be repaired before proceeding. Refer to the vehicle service manual. Some publications have this information in books or sections called "Computerized Engine Controls", "Electronic Engine Controls", or "Tune-Up Information."

- 5) Turn the Diagnosis Mode Selector fully COUNTERCLOCKWISE.

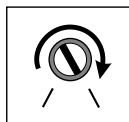

- 6) Have your pencil and paper ready.

- 7) (For Maxima and 300ZX only. If 300ZX Turbo, go to Step 13.) Depress and release accelerator pedal.

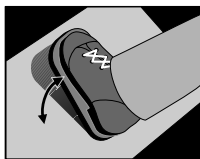

- 8) Start the vehicle's engine.

- 9) Apply the brakes, and move the gear shift lever to Drive.

- 10) Turn the headlamp switch, or the rear defogger switch ON and then back to OFF.

- 11) Observe the RED and GREEN LED's.

- Code 44 should be displayed.
- Note any codes other than 44.

- 12) This completes trouble code retrieval for Maxima and 300ZX.

- Turn the Diagnosis Mode Selector fully COUNTERCLOCKWISE, then the ignition switch to the OFF position.

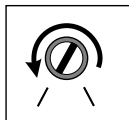

- **IMPORTANT:** Turn the Diagnosis Mode Selector to its initial position (setting) as marked in Step 1 of the test procedure.

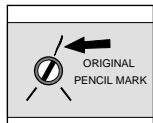

- Proceed to the "What to do with the Trouble Codes" section below. (Skip steps 13 through 18.)

- 13) **300ZX Turbo only:** Move the gear shift lever from Neutral to all other gears and then back to Neutral.



- 14) Start the vehicle's engine.

- 15) Drive the vehicle at a speed of greater than 6 MPH. **Warning:** Get the help of another person for this step!

- 16) Turn the A/C switch, and the heater fan switch ON and then back to OFF.



- 17) Observe the RED and GREEN LED's.

- Code 44 should be displayed.
- Note any codes other than 44.

- 18) This completes trouble code retrieval for 300ZX Turbo.

- Turn the Diagnosis Mode Selector fully COUNTERCLOCKWISE, then the ignition switch to the OFF position.

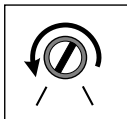

- **IMPORTANT:** Turn the Diagnosis Mode Selector to its initial position (setting) as marked in Step 1 of the test procedure.

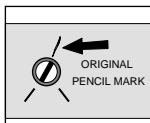

What to do with the Trouble Codes

Look up the code definitions listed in Section 12, "Nissan Code Meanings,"

At this point you can either:

- Have your vehicle professionally serviced. Trouble codes indicate problems found by the computer.
- or,
- Repair the vehicle yourself using trouble codes to help pinpoint the problem. Refer to Section 3, "Using Codes." Be sure to erase any trouble codes from the computer's memory after repairs are completed, as indicated below.

Erasing Trouble Codes after Repair

- 19) Turn the ignition switch to the ON position, but do not start the engine.

- 20) Turn the Diagnosis Mode Selector fully CLOCKWISE, and wait at least 3 seconds.

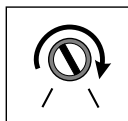

- 21) Turn the Diagnosis Mode Selector fully COUNTERCLOCKWISE, and wait at least 3 seconds.

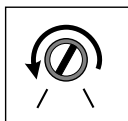

- 22) Turn the ignition switch to the OFF position.

Trouble Codes are now erased!

- 23) **IMPORTANT:** Turn the Diagnosis Mode Selector to its initial position (setting) as marked in Step 1 of the test procedure.

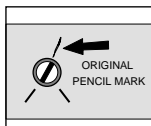

NOTE: When reinstalling the computer, be careful to route all wiring to its original position.

1986 1/2 Pickup

Warning: Involves running engine. Observe all safety precautions (see page 2). Work in well ventilated area.

- 1) Start the vehicle's engine and warm it to normal operating temperature.

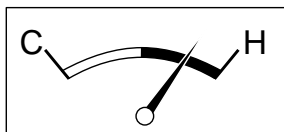

- 2) Drive the vehicle for about ten minutes after it has fully warmed up.

- 3) Park the vehicle and turn the ignition switch OFF.

- 4) Verify that the Diagnosis Mode Selector is in the OFF position.

- 5) Turn the ignition switch ON, but do not start the engine.

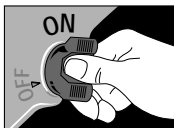

- 6) Turn the Diagnosis Mode Selector switch ON.

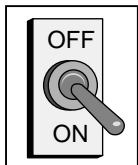

- 7) Have your pencil and paper ready.

- 8) Observe the RED and GREEN LED's.

- Codes **24**, and **31** should be displayed.
- Note any codes **other than 24**, and **31**.

- 9) Turn the headlamp switch ON, then back to OFF.

- 10) Observe the RED and GREEN LED's.

- Code **24** should be displayed.
- Note any codes **other than 24**.

- 11) (For Manual Transmission only. If Automatic Transmission, go to Step 15.) Depress the clutch and move the gear shift lever from Neutral to any other gear and completely release the clutch.

- 12) Depress the clutch again and move the gear shift lever back to Neutral.

- 13) Observe the RED and GREEN LED's.

- Code **44** should be displayed.
- Note any codes **other than 44**.

- 14) This completes trouble code retrieval for manual transmission Pickup.

- Turn the Diagnosis Mode Selector switch OFF, and the ignition switch to the OFF position.
- Proceed to the "What to do with the Trouble Codes" section below. (Skip steps 15 through 17.)

- 15) **Automatic Transmissions only:** Move the gear shift lever from the Park or Neutral position to any other position and back to the Park or Neutral position.

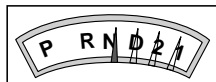

- 16) Observe the RED and GREEN LED's.

- Code **44** should be displayed.
- Note any codes **other than 44**.

- 17) This completes trouble code retrieval for automatic transmission Pickup. Turn the Diagnosis Mode Selector switch OFF, and the ignition switch to the OFF position.

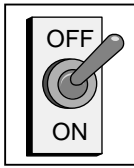

What to do with the Trouble Codes

Look up the code definitions listed in Section 12, "Nissan Code Meanings,"

At this point you can either:

- Have your vehicle professionally serviced. Trouble codes indicate problems found by the computer.
or,
- Repair the vehicle yourself using trouble codes to help pinpoint the problem. Refer to Section 3, "Using Codes." Be sure to erase any trouble codes from the computer's memory after repairs are completed, as follows:

Erasing Trouble Codes after Repair

- 18) Turn the ignition switch to the ON position, but do not start the engine.

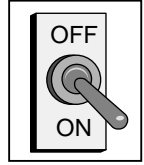

- 19) Switch the Diagnosis Mode Selector ON, and wait at least 3 seconds.

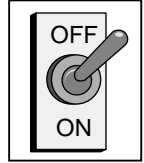

- 20) Switch the Diagnosis Mode Selector OFF, and wait at least 3 seconds.

- 21) Turn the ignition switch to the OFF position.

Trouble Codes are now erased!



NOTE: When reinstalling the computer, be careful to route all wiring to its original position.

- 1987 All models except Pathfinder, Pickup, Van
- 1988 All models except Pathfinder, Pickup, Van
- 1989 All models except Pathfinder, Pickup
- 1990 All models (including Axxess) except Stanza, Van, 300SX
- 1991 Maxima, Pathfinder, Pickup
- 1992 Maxima with VG30E engine, Pathfinder, Pickup

Preliminary Checks

Nissan service manuals list several checks which should be made before reading trouble codes. Problems in the areas listed below can cause the computer to set false or misleading codes. Ignoring these checks can make you miss the real cause of a code! This can lead to the unnecessary replacement of good parts. Service manual procedures for troubleshooting a code assume all preliminary checks are good. These checks vary with vehicle. Typical checks are listed below. Refer to service manual for your vehicle requirements.

- Visually inspect electrical wiring and connectors.
- Visually inspect vacuum hoses and connectors.
- Perform a compression test.
- Perform an exhaust system backpressure test.
- Perform a fuel pressure test.
- Check curb idle speed.
- Check ignition timing.
- Check computer control of air/fuel mixture.
- Check the idle speed switch.
- Perform a Mode 5 check, while test driving the vehicle.

Reading Trouble Codes: All listed vehicles

- 1) Mark the initial setting of the Diagnostic Mode Selector on the computer housing.

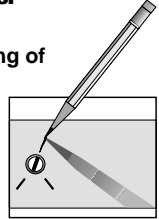

IMPORTANT: *The Diagnostic Mode Selector is a potentiometer. It is critical that the initial position (setting) of this potentiometer be marked on the computer housing so that when testing is complete, it can be reset to its original position!*

- 2) Turn the ignition switch ON, but do not start the engine.

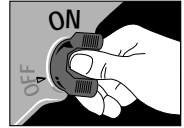

- 3) Turn the Diagnosis Mode Selector fully CLOCKWISE.

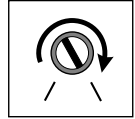

- 4) Observe the RED and GREEN LED's.



- 5) Both LED's will flash sequentially 1 through 5 (1 flash = Mode 1, 2 flashes = Mode 2, etc.).

- 6) When Mode 3 (Trouble Codes) has been reached, as indicated by 3 flashes, immediately turn the Diagnosis Mode Selector fully COUNTERCLOCKWISE.



7) Have your pencil and paper ready.

8) Write down all displayed Trouble Codes.

9) This completes trouble code retrieval on these vehicles. Turn ignition key OFF. (The computer will automatically return to normal operation.)



10) **IMPORTANT:** Turn the Diagnosis Mode Selector to its initial position (setting) as marked in Step 1 of the test procedure.

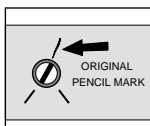

What to do with the Trouble Codes

Look up the code definitions listed in Section 12, "Nissan Code Meanings,"

At this point you can either:

- Have your vehicle professionally serviced. Trouble codes indicate problems found by the computer.
or,
- Repair the vehicle yourself using trouble codes to help pinpoint the problem. Refer to Section 3, "Using Codes." Be sure to erase any trouble codes from the computer's memory after repairs are completed, as indicated below.

Erasing Trouble Codes after Repair

11) Turn the ignition switch ON, but do not start the engine.

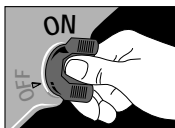

12) Turn the Diagnosis Mode Selector fully CLOCKWISE.

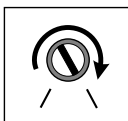

13) Observe the RED and GREEN LED's. They will flash sequentially 1 through 5 (1 flash = Mode 1, 2 flashes = Mode 2, etc.).

14) When Mode 3 (Trouble Codes) has been reached, as indicated by 3 flashes, immediately turn the Diagnosis Mode Selector fully COUNTERCLOCKWISE.

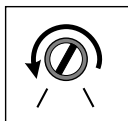

15) Allow all stored Trouble Codes to flash.

16) Turn the Diagnosis Mode Selector fully CLOCKWISE once again.

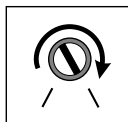

17) Observe the RED and GREEN LED's. They will flash sequentially 1 through 5 (1 flash = Mode 1, 2 flashes = Mode 2, etc.).

18) When Mode 4 (Erase Codes) has been reached, as indicated by 4 flashes, immediately turn the Diagnosis Mode Selector fully COUNTERCLOCKWISE.

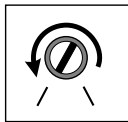

19) Turn the ignition key OFF. (The computer will automatically return to normal operation.)



Trouble Codes are now erased!

20) **IMPORTANT:** Turn the Diagnosis Mode Selector to its initial position (setting) as marked in Step 1 of the test procedure.

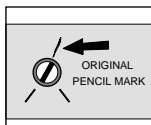

NOTE: When reinstalling the computer, be careful to route all wiring to its original position.

1987 Pathfinder, Pickup, Van
1988 Pathfinder, Pickup, Van
1989 Pathfinder, Pickup
1990 Van (not Axxess)

Preliminary Checks

Nissan service manuals list several checks which should be made before reading trouble codes. Problems in the areas listed below can cause the computer to set false or misleading codes. Ignoring these checks can make you miss the real cause of a code! This can lead to the unnecessary replacement of good parts. Service manual procedures for troubleshooting a code assume all preliminary checks are good. These checks vary with vehicle. Typical checks are listed below. Refer to service manual for your vehicle requirements.

- Visually inspect electrical wiring and connectors.
- Visually inspect vacuum hoses and connectors.
- Perform a compression test.
- Perform an exhaust system backpressure test.
- Perform a fuel pressure test.
- Check curb idle speed.
- Check ignition timing.
- Check computer control of air/fuel mixture.
- Check the idle speed switch.
- Perform a Mode 5 check, while test driving the vehicle.

Reading Trouble Codes: All listed vehicles

- 1) Turn the ignition switch ON, but do not start the engine.

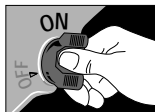

- 2) Turn the Diagnosis Mode Selector ON.

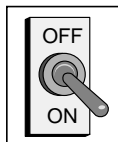

- 3) Observe the RED and GREEN LED's.



- 4) Both LED's will flash sequentially 1 through 5 (1 flash = Mode 1, 2 flashes = Mode 2, etc.).

- 5) When Mode 3 (Trouble Codes) has been reached, as indicated by 3 flashes, immediately turn the Diagnosis Mode Selector OFF.

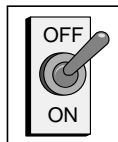

- 6) Have your pencil and paper ready.

- 7) Write down all displayed Trouble Codes.

- 8) This completes trouble code retrieval on these vehicles. Turn the Diagnosis Mode Selector switch OFF, and the ignition switch to the OFF position. (The computer will automatically return to normal operation.)



What to do with the Trouble Codes

Look up the code definitions listed in Section 12, "Nissan Code Meanings,"

At this point you can either:

- Have your vehicle professionally serviced. Trouble codes indicate problems found by the computer.
or,
- Repair the vehicle yourself using trouble codes to help pinpoint the problem. Refer to Section 3, "Using Codes." Be sure to erase any trouble codes from the computer's memory after repairs are completed, as follows:

Erasing Trouble Codes after Repair

- 9) Turn the ignition switch **ON**, but do not start the engine.



- 10) Turn the Diagnosis Mode Selector **ON**.

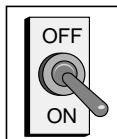

- 11) Observe the **RED** and **GREEN** LED's. They will flash sequentially 1 through 5 (1 flash = Mode 1, 2 flashes = Mode 2, etc.).

- 12) When Mode 3 (Trouble Codes) has been reached, as indicated by 3 flashes, immediately turn the Diagnosis Mode Selector **OFF**.

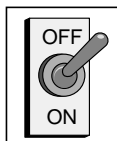

- 13) Allow all stored Trouble Codes to flash.

- 14) Turn the Diagnosis Mode Selector **ON** once again.

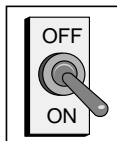

- 15) Observe the **RED** and **GREEN** LED's. They will flash sequentially 1 through 5 (1 flash = Mode 1, 2 flashes = Mode 2, etc.).

- 16) When Mode 4 (Erase Codes) has been reached, as indicated by 4 flashes, immediately turn the Diagnosis Mode Selector **OFF**.

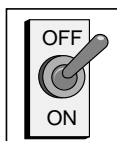

- 17) Turn the ignition key **OFF**. (The computer will automatically return to normal operation.)



Trouble Codes are now erased!

NOTE: When reinstalling the computer, be careful to route all wiring to its original position.

- 1990 Stanza, 300ZX
- 1991 NX, Sentra, Stanza, 240SX, 300ZX
- 1992 Maxima w/VE30DE (DIS) engine, NX, Sentra, Stanza, 240SX, 300ZX

Preliminary Checks

Nissan service manuals list several checks which should be made before reading trouble codes. Problems in the areas listed below can cause the computer to set false or misleading codes. Ignoring these checks can make you miss the real cause of a code! This can lead to the unnecessary replacement of good parts. Service manual procedures for troubleshooting a code assume all preliminary checks are good. These checks vary with vehicle. Typical checks are listed below. Refer to service manual for your vehicle requirements.

- Visually inspect electrical wiring and connectors.
- Visually inspect vacuum hoses and connectors.
- Perform a compression test.
- Perform an exhaust system backpressure test.
- Perform a fuel pressure test.
- Check curb idle speed.
- Check ignition timing.
- Check computer control of air/fuel mixture.
- Check the idle speed switch.

Reading Trouble Codes:

All listed vehicles

- 1) Mark the initial setting of the Diagnostic Mode Selector on the computer housing.

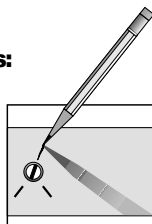

IMPORTANT: *The Diagnostic Mode Selector is a potentiometer. It is critical that the initial position (setting) of this potentiometer be marked on the computer housing so that when testing is complete, it can be reset to its original position!*

- 2) Turn the ignition switch ON, but do not start the engine.



- 3) Turn the Diagnosis Mode Selector fully CLOCKWISE. Wait 3 seconds.

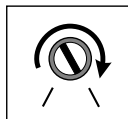

- 4) Turn the Diagnosis Mode Selector fully COUNTERCLOCKWISE. The RED LED will begin to flash. The computer is now in Mode 2 (Trouble Codes).

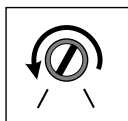

- 5) Have your pencil and paper ready.
- 6) Write down all displayed Trouble Codes.

- 7) This completes trouble code retrieval on these vehicles. Turn ignition key OFF. (The computer will automatically return to normal operation.)



- 8) **IMPORTANT:** Turn the Diagnosis Mode Selector to its initial position (setting) as marked in Step 1 of the test procedure.

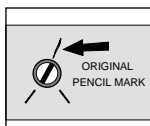

What to do with the Trouble Codes

Look up the code definitions listed in Section 12, "Nissan Code Meanings,"

At this point you can either:

- Have your vehicle professionally serviced. Trouble codes indicate problems found by the computer.

or,

- Repair the vehicle yourself using trouble codes to help pinpoint the problem. Refer to Section 3, "Using Codes." Be sure to erase any trouble codes from the computer's memory after repairs are completed, as follows:

Erasing Trouble Codes after Repair

- 9) Turn the ignition switch ON, but do not start the engine.

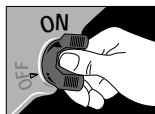

- 10) Turn the Diagnosis Mode Selector fully CLOCKWISE. Wait 3 seconds and turn the Diagnosis Mode Selector fully COUNTERCLOCKWISE.

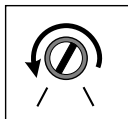
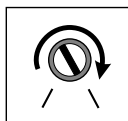

- 11) Turn the ignition key OFF. (The computer will automatically return to normal operation.)



Trouble Codes are now erased!

- 12) **IMPORTANT:** Turn the Diagnosis Mode Selector to its initial position (setting) as marked in Step 1 of the test procedure.

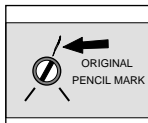

NOTE: When reinstalling the computer, be careful to route all wiring to its original position.

Code Meanings

Note:

- Code meanings can vary with vehicle, model year, engine type and options.
- If a code number has more than one definition listed, note that only one definition applies to your vehicle. Consult service manual to get the specific definition for your vehicle.
- Each code definition includes a list of possible causes for the code.
- Follow vehicle service manual procedures to find the cause of the code.

11

Crank (Crankshaft) Angle sensor

- Bad or dirty Crank Angle sensor, Electronic Concentrated Control System (ECCS) relay, Main Relay, EFI Main Relay or Ignition switch. Faulty sensor, relay or switch wiring. Crank Angle sensor harness is near spark plug wires.

or,

Crank Angle switch - Bad or dirty Crank Angle switch or faulty switch wiring.

12

Mass Airflow sensor - Bad Mass Airflow sensor, Air Flow Meter, Electronic Concentrated Control System (ECCS) relay, Main relay, Ignition switch or Fuel Injector(s). Faulty wiring associated with these parts.

NOTE: If vehicle is equipped with Air Temperature sensor and codes 41 and 12 are present, check Air Temperature sensor before MAF sensor.

or,

Air Flow meter - Bad Air Flow meter, Electronic Fuel Injection (EFI) Main relay, Main relay, Electronic Concentrated Control System (ECCS) relay, Ignition switch, Fuel Injector(s) or faulty wiring associated with these parts.

13

Coolant Temperature sensor

- Bad Coolant Temperature sensor, Engine Temperature sensor, Cylinder Head Temperature sensor, Water Temperature sensor, or faulty sensor wiring.

or,

Engine (Coolant) Temperature sensor

- Bad Engine Temperature sensor or faulty sensor wiring.

or,

Water (Coolant) Temperature Sensor

- Bad Water Temperature sensor or faulty sensor wiring.

or,

Cylinder Head Temperature sensor

- Bad Cylinder Head Temperature sensor or faulty sensor wiring.

14

Vehicle Speed Sensor (VSS)

- Bad Vehicle Speed Sensor (VSS), Speedometer unit or faulty sensor wiring.

21

No Ignition Reference (Pulse)

- Bad Ignition Coil, Power Transistor, Power Transistor relay, Ignition Coil relay, Ignition switch, Resistor, Condenser, IC Ignition unit, Detonation sensor (if code 34 also) or faulty wiring associated with these parts.

or,

Remember:

- 1) Visual inspections are important!
- 2) Problems with wiring and connectors are common, especially for intermittent faults.
- 3) Mechanical problems (vacuum leaks, binding or sticking linkages, etc.) can make a good sensor send an incorrect signal to the computer. This can cause a Trouble Code.
- 4) Incorrect information from a sensor may cause the computer to control the engine in the wrong way. Faulty engine operation might even make the computer show a different good sensor as being bad!

Ignition signal

- Bad Spark Plug(s), Ignition wires, Distributor cap, distributor rotor, power transistor, Power Transistor relay, Ignition switch or faulty wiring associated with these parts.

or,

Ignition System - Bad Distributor, Ignition coil or IC Ignition unit. Faulty Spark plug wires or wiring associated with these parts.

22

Fuel Pump - Bad Safety Relay, Electronic Fuel Injection (EFI) Safety relay, Fuel Pump, Fuel Pump relay, Ignition switch, Crank Angle sensor or faulty wiring associated with these parts.

or,

Idle Speed Control (ISC) valve - Bad ISC valve or faulty valve wiring.

23

Idle switch - Bad or out of adjustment Idle switch, Ignition switch, Electronic Fuel Injection (EFI) relay, Electronic Concentrated Control System (ECCS) relay, Main relay or faulty switch/relay wiring.

or,

Throttle Valve switch - Bad or out of adjustment Idle switch, Throttle Valve switch, Ignition

switch, Electronic Fuel Injection (EFI) relay, Electronic Concentrated Control System (ECCS) relay, Main relay or faulty switch/relay wiring.

or,

Throttle Valve Idle switch - Out of adjustment or Bad Throttle Valve Idle switch or faulty switch wiring.

24

Idle switch - Bad or out of adjustment Idle switch, Ignition switch, Throttle Valve switch or faulty switch wiring.

or,

Transmission switch - Bad Neutral switch or faulty switch wiring.

or,

Neutral/Park switch - Bad Neutral/Park switch or faulty switch wiring.

25

Idle Speed Control - Bad Auxiliary Air Control (AAC) valve, Idle Speed Control valve (ISC) or faulty valve wiring.

31

Electronic Control Unit (ECU) - Bad ECU or faulty ECU wiring.

or,

Air Conditioning (A/C) switch - Bad A/C switch or faulty switch wiring.

or,

Lighting switch - Bad Lighting switch or faulty switch wiring.

or,

Fan switch - Bad Fan switch or faulty switch wiring.

or,

Power Steering switch - Bad Power Steering switch or faulty switch wiring.

or,

Air Conditioner (A/C) - Improper A/C Compressor operation or faulty compressor wiring.

or,

Load signal - Fault in Load system.

32

Exhaust Gas Recirculation (EGR) sensor - Bad EGR Control valve, EGR Control Solenoid valve, Exhaust Gas Temperature sensor, Back Pressure Transducer (BPT) valve or Canister Control Solenoid valve. Clogged vacuum port. Faulty Vacuum lines or valve/sensor wiring.

or,

Starter switch - Faulty starting circuit components or starting circuit wiring.

or,

Start signal - Faulty Starter system wiring.

33

Oxygen (O₂) sensor - Bad Exhaust Gas sensor, O₂ sensor, Ignition switch or faulty sensor/switch wiring.

or,

Exhaust Gas sensor - Bad Exhaust Gas sensor, Ignition switch or faulty sensor/switch wiring.

34

Knock (Detonation) sensor - Bad Detonation sensor or faulty sensor wiring.

35

Exhaust Gas Recirculation (EGR) Temperature (TEMP) sensor - Bad Exhaust Gas Temperature sensor, EGR Control valve or faulty sensor/valve wiring.

41

Air Temperature (TEMP.) sensor - Bad Air Temperature sensor or faulty sensor wiring.

or,

Fuel Temperature sensor - Bad Fuel Temperature sensor or faulty sensor wiring.

42

Fuel Temperature sensor - Bad Fuel Temperature sensor or faulty sensor wiring.

or,

Throttle sensor - Bad or out of adjustment Throttle sensor. Bad Main relay, Ignition switch or faulty sensor/relay/switch wiring.

or,

Throttle switch - Bad Throttle sensor or faulty sensor wiring.

43

Throttle Position sensor - Bad or out of adjustment Throttle Position sensor or Idle Switch. Bad Electronic Concentrated Engine Control System (ECCS) relay, Main Relay, Throttle sensor, Electronic Fuel Injection (EFI) relay, Ignition switch or faulty sensor/switch/relay wiring.

or,

Fuel Injector - Bad Fuel injector(s), safety relay or faulty injector/relay wiring.

45

Injector (Injection) leak - Bad Fuel Injector(s), Vehicle Speed sensor, Exhaust Gas sensor, Idle switch or Fuel Injector "O" ring. Improper Idle Carbon Monoxide % (CO%). Faulty Mixture-Ratio feedback system.

51

Fuel Injector(s) (electrical) - Bad Fuel Injector(s), Safety Relay or faulty injector/relay wiring.

53

Oxygen (O₂) sensor - Bad Exhaust Gas sensor, O₂ sensor or faulty sensor wiring.

54

Automatic Transmission (A/T) signal - Bad connections between Transmission Control unit and ECU. Bad Fuel Injector(s) or faulty wiring associated with these parts.

55

No Malfunction recorded.

Computer Basics

This section explains the engine computer control system, the types of sensors and how the computer controls fuel delivery, idle speed, spark timing and emission devices.

The following is a general introduction to computer controlled engine systems. Additional information may be found in books dealing with this subject available at your local library or auto parts store. The more you know about the computer system, the better and faster you can troubleshoot and fix problems.

Why Computers?

Computer controls were installed in vehicles to meet Federal Government regulations for lower emissions and better fuel economy. This all began in the early 1980's when purely mechanical control systems just were not good enough anymore. A computer could be programmed to precisely control the engine under various operating conditions and eliminate some mechanical parts making the engine more reliable.

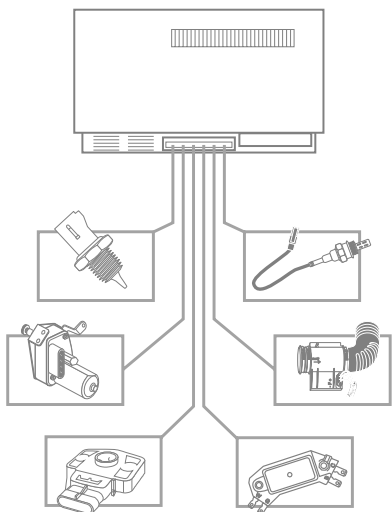

What the computer controls

The main control areas of the computer are:

- Fuel delivery
- Idle speed
- Spark advance timing
- Emission devices (EGR valve, carbon canister, etc.)

Some early systems only controlled fuel delivery. The other functions were added soon after.

The changes made to the basic engine to allow a computer to control these tasks are the only differences between an older engine and a computerized one. A little later we will discuss just how the computer handles these tasks.

What has NOT changed?

A computer controlled engine is basically the same as earlier types. It is still an internal combustion engine with pistons, spark plugs, valves and cams. The ignition, charging, starting, and exhaust systems are almost the same, as well. You test and repair these systems the same way as before, using familiar tools. The instruction manuals for these tools show you how to perform the tests. Your compression gauge, vacuum pump, dwell-tach meter, engine analyzer, timing light, etc., are still valuable!

The Engine Computer Control System

The computer module is the "heart" of the system. It is sealed in a metal box and linked to the rest of the system by a wiring harness. The computer module is located in the passenger compartment, usually under the seat, behind the dashboard or front kick panels. This protects the electronics from moisture, extreme temperatures and excess vibration, which are common in the engine compartment.

The computer module is the “heart” of the system

The computer is permanently programmed by factory engineers. The program is a complex list of instructions telling the computer how to control the engine under various driving conditions. To do its job, the computer needs to know what is happening and then it needs devices to control things.

Sensors give the computer information

The computer can only work with electrical signals. The job of the sensor is to take something the computer needs to know, such as engine temperature, and convert it to an electrical signal which the computer can understand. You can think of sensors as “high tech” senders - the devices found in older vehicles for gauges and dashboard message lights (oil pressure, fuel level, etc). Signals running into the computer are referred to as “inputs.”

Sensors monitor such things as:

- Engine temperature
- Intake manifold vacuum
- Throttle position
- RPM
- Incoming air (temperature, amount)
- Exhaust gas oxygen content
- EGR Valve flow

Most engine computer systems will use the sensor types listed above. Additional sensors may be used depending upon the engine, vehicle type or other tasks the computer must do. Note that information from one sensor may be used by the computer for many different tasks. For

example, engine temperature is something the computer needs to know when controlling fuel delivery, spark timing, idle speed and emission systems. The sensor information may be very important for one engine control function, but only used to “fine tune” a second one.

There are several types of sensors

- *Thermistor* - This is a resistor whose resistance changes with temperature. It is used to measure temperatures of coolant or incoming air. It has two wires connected to it.
- *Potentiometer* - This signals a position, such as throttle position or EGR valve position. It connects to three wires: one for power, one for ground and one to carry the position signal back to the computer.
- *Switches* - These are either ON (voltage signal to the computer) or OFF (no voltage signal to the computer). Switches connect to two wires and tell the computer simple things, such as whether or not the air conditioner is running.
- *Signal Generator* - These create their own signal to tell the computer of some condition, such as exhaust gas oxygen content, camshaft position, or intake manifold vacuum. They may have one, two or three wires connected to them.

Actuators are energized by the computer to control things

The computer can only send out electrical signals (referred to as “outputs”). Devices called actuators are powered by the computer to control things. Actuator types include:

- *Solenoids* - These are used to control a vacuum signal, bleed air, control fuel flow, etc.
- *Relays* - These switch high amperage power devices on and off, such as electric fuel pumps or electric cooling fans.
- *Motors* - Small electric motors can be used to control idle speed.

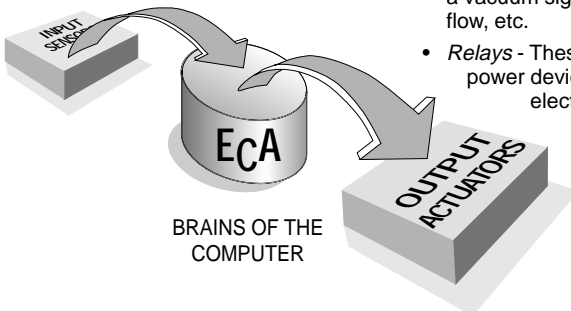

Other output signals

Not all of the computer outgoing signals go to actuators. Sometimes information is sent to electronic modules, such as ignition or trip computer.

How the computer controls Fuel Delivery

Good driveability and emission performance depends upon precise fuel control. Early computer controlled vehicles used electronically adjustable carburetors, but fuel injectors were soon used later on.

The job of the computer is to provide the optimum mixture of air and fuel (air/fuel ratio) to the engine for best performance under all operating conditions.

The computer needs to know:

- ...what the engine operating condition is.

Sensors used: coolant temperature, throttle position, manifold absolute pressure, mass air flow, RPM.

- ...how much air is coming into the engine.

Sensors used: mass air flow, vane air meter or a combination of manifold absolute pressure, manifold air temperature, RPM.

- ...how much fuel is being delivered.

The computer knows this by how long it turns on the fuel injectors. (The computer uses a solenoid to adjust air/fuel mixture on electronic controlled carburetors.)

- ...that everything is working the way it should.

Sensor used: exhaust gas oxygen sensor.

Note: Not all engines use every sensor listed above.

Cold engine warm-up condition

“Open Loop” operation

The coolant temperature sensor tells the computer how warm the engine is. Factory engineers know what the best air/fuel mixture is for the engine at various operating temperatures. (More

fuel is needed for a cold engine.) This information is permanently programmed into the computer. After the computer knows the engine temperature, it determines the amount of air coming in, then it will look at its programming to find out how much fuel to deliver and operate the fuel injectors accordingly. (Computerized engines with carburetors don't do any of this. They use a conventional carburetor choke mechanism.)

This is an example of “Open Loop” operation by the computer. The control system performs an action (expecting a certain result), but has no way of verifying if the desired results were achieved. In this case, the computer pulses a fuel injector expecting a certain amount of fuel to be delivered. (The computer assumes everything in the fuel system is operating as expected.) In open loop operation, the computer has no way of checking the actual amount of fuel delivered. Thus, a faulty injector or incorrect fuel pressure can change the amount of fuel delivered and the computer would not know it.

Hot engine cruise condition

“Closed Loop” operation

The computer watches the coolant temperature and throttle position sensors to tell when the engine is all warmed up and cruising. As before, the computer determines the amount of air coming into the engine, then delivers the amount of fuel that should provide the optimum air/fuel mixture. The big difference is that this time the computer uses the oxygen sensor to check how well it's doing and re-adjust things, if needed, to make sure the fuel delivery is correct.

This is an example of “Closed Loop” operation. The control system performs an action (expecting a certain result), then checks the results and corrects its actions (if necessary) until the desired results are achieved.

The oxygen sensor only works when it is very hot. Also, it can only monitor the “hot engine” air/fuel mixture value and send back a signal to the computer. The sensor can not monitor the other air/fuel mixture values used during engine

warm-up, so the computer must operate “open loop” at that time.

Acceleration, deceleration and idle conditions

As long as the engine and oxygen sensor are hot, the computer can operate “closed loop” for best economy and least emissions. During the drive conditions listed above, the computer may have to ignore the sensor and run “open loop,” relying on internal programming for fuel delivery instructions. During idle, for example, the oxygen sensor may cool down and stop sending a signal. A different situation can occur during wide-open-throttle acceleration. The computer sometimes adds additional fuel (on purpose) for temporary acceleration power. The computer knows it is running “rich” so it ignores the sensor signal until the wide-open-throttle condition is over.

Other fuel control functions

Various systems may have the computer controlling other aspects of air or fuel delivery for performance enhancements. These may include...

- Switchable air intake path length for best high or low RPM performance.
- Variable valve timing.
- Using a “cold start” injector to aid start-up.
- Controlling fuel pressure.

Refer to electronic control system description in vehicle service manual for details.

How the computer controls Idle Speed

Early Systems:

Idle speed is mechanically set, but the computer can increase it by a fixed amount. A computer controlled solenoid can open a small air passage bypassing the closed throttle plate. The additional air flow increases the idle speed by a fixed amount. This idle speed boost is necessary when engine loading results from air conditioning, power steering or similar demands. (Otherwise the engine

might stall.) Signals from such systems tell the computer when engine loading is about to occur. Some engines have more than one such throttle air bypass.

Later Systems:

Throttle position and RPM sensors tell the computer when the vehicle is idling. (Sometimes an idle position switch on the throttle is used.) The computer watches RPM and adjusts an idle speed control device on the vehicle to maintain the desired idle condition. Note that this is another example of “closed loop” operation. The computer performs an action (activating an idle control device), then watches the results of its action (engine RPM) and readjusts as necessary until the desired idle speed is achieved.

Idle speed is controlled by adjusting throttle bypass air as in the early systems. The difference is that the computer can change idle speed by varying amounts instead of a fixed amount. One method uses a small electric motor to adjust an air valve opening in the bypass passage. The other way uses a solenoid switched with a “duty cycle” type signal from the computer. Refer to Duty Cycle definition in the Glossary (Section 14).

How the computer controls Spark Advance Timing

You set spark timing in a non-computer controlled ignition by using a timing light and adjusting the distributor at idle RPM. During vehicle operation, timing is changed by either engine vacuum (vacuum advance function) or by engine RPM (centrifugal advance function.) These spark timing changes are done mechanically inside the distributor.

Computer controlled ignitions using a distributor still have you set spark timing by using a timing light and adjusting the distributor at idle RPM. The timing changes which occur during vehicle operation, however, are controlled electronically. The computer looks at sensors to determine vehicle speed, engine load and temperature. (RPM, throttle position, coolant temperature and manifold pressure, vane air flow or

mass air flow sensors are used.) Then, the computer adjusts timing according to factory programmed instructions. The computer sends a timing signal to an ignition module which eventually creates the spark.

A simpler version uses a conventional distributor with mechanical timing. Here, the computer controls a solenoid to change the vacuum advance timing by a fixed amount when desirable.

Some vehicles have a “knock” sensor. The computer can “fine tune” the spark timing if this sensor signals an engine knock condition.

Newer ignition systems have no distributor. They are called Distributorless or Direct Ignition Systems (DIS). Sensors for camshaft and crankshaft position, in addition to the sensors mentioned before, are used by the computer to determine spark timing. Multiple coils wired to the spark plugs are fired directly from computer signals.

Computer Controlled Emission Systems

EGR Valve

The EGR valve lets exhaust gases re-enter the intake manifold and mix with the incoming air/fuel. The presence of exhaust gases reduces combustion temperatures in the cylinders and this reduces poisonous NO_x emissions. The computer controls the flow of gases through the EGR valve. The EGR system is only used during warm engine cruise conditions. A partially open EGR valve at other times can cause stalling.

Air Injection System

This system works with the catalytic convertor. The computer takes outside air from an air pump and directs it to the exhaust manifold as necessary for best emission performance. (The extra air helps partially burned exhaust gases to completely burn and reduce pollution.)

Fuel Evaporation Recovery System

A special canister collects vapors evaporating from the fuel tank, preventing them from escaping into the atmosphere and causing pollution. During warm engine cruise conditions, the computer draws the trapped vapors into the engine for burning.

Other computer functions

The computer controls other odd jobs like handling “speed control” and transmission torque convertor lock-up and shifting functions. Detailed explanations may be found in your vehicle service manual.

More information

The Glossary describes various sensors and actuators used in computer controlled engine systems. You can learn more by reading these definitions.

Glossary

AAC

See Auxiliary Air Control valve.

A/C

Air Conditioning.

A/C Amplifier

The A/C Amplifier sends a signal to the ECU representing the temperature at the Evaporator outlet. The ECU then adjusts the engine cooling fan operation as necessary.

A/C Switch

Air Conditioning switch. Switch signals ECU when Air Conditioning is activated. The ECU will increase idle speed to prevent engine stalling whenever Air Conditioning is engaged.

Actuator

Devices which are powered by the ECU to control mechanical things. Actuator types include relays, solenoids and electric motors. Actuators allow the ECU to control engine operation.

A/F

Air to Fuel ratio. This refers to the proportion of air and fuel delivered to the cylinder for combustion. For example, if you have 14 times more air than fuel (by weight) than the A/F ratio is 14:1 (read as "fourteen to one"). Note that a colon is written instead of a slash.

AFM

See Air Flow Meter.

Air Cut Valve

The Air Cut Valve is mounted on the Auxiliary Air Control valve (AAC). It limits the amount of air flowing through the AAC based on coolant temperature to reduce the possibility of dieseling (engine run-on with ignition key off).

Air Flow Meter (AFM)

The part of the air intake system containing the Air Flow sensor.

Air Flow Sensor

This sensor measures the amount of air entering the engine and sends a signal to the ECU. Depending upon sensor type, the signal may be a voltage or frequency. The signal voltage (or frequency) increases when the amount of incoming air goes up. The ECU needs to know incoming air flow to properly adjust air/fuel mixture and ignition timing for varying engine load and operating conditions.

Air Induction System

System including but not limited to the Air Intake system, By-Pass Control system, Intake Control system and Throttle Body.

Air Injection Valve (AIV)

The AIV is a one way reed valve with a lock-out diaphragm. When negative exhaust pressure is present, the AIV will allow air to enter the exhaust manifold allowing burning of HC and CO in the catalytic converter.

Air Intake System

This system contains components like the air cleaner, air intake pipe, throttle body, fast idle mechanism, intake manifold, Electronic air control valve and bypass control system.

Air Pump Injection System

A system that reduces HC and CO emissions by injecting air into the exhaust manifold. The extra air helps partially burned exhaust gases to completely burn and reduce pollution.

Air Regulator

The Air regulator allows some air to bypass a closed throttle. Used when the engine is cold for fast idle.

Air Suction System (AS)

The Air Suction system draws air into the exhaust port to reduce the HC and CO emissions. The extra air helps partially burned exhaust gases to completely burn and reduce pollution.

Air Temperature Sensor (TA)

This sensor is a thermistor – a resistor whose resistance changes with temperature. The hotter the sensor gets, the lower the resistance becomes. The sensor is located along the path of air entering the engine. The ECU uses air temperature to provide the proper air/fuel mixture for the desired engine operating condition.

AIV

See Air Injection Valve.

AP

Air pump. Used in Air Pump Injection System.

AS

See Air Suction System.

A/T

Automatic Transmission.

ATC

See Automatic Temperature control.

ATCV

See Automatic Transmission / Transaxle Control.

Atmospheric Pressure Sensor (PA)

This sensor is an electronic module which sends a signal to the ECU indicating atmospheric pressure. Depending upon sensor type, the signal may be a dc voltage or a frequency. More pressure makes the sensor signal increase (higher voltage or frequency). The ECU needs to know air pressure to

properly adjust air/fuel mixture and ignition timing for varying engine load and altitude conditions.

Automatic Temperature Control (ATC)

Maintains a relatively constant intake air temperature.

Auxiliary Air Control valve (AAC)

The ECU uses the AAC to adjust idle speed by changing the amount of air bypassing the throttle plate. Idle speed increases as more air bypasses the throttle through the AAC.

Back Pressure Transducer Valve (BPT)

Bleeds off vacuum signal to EGR valve when operation is not desirable.

BPT

See Back Pressure Transducer.

Bypass Control System

The Bypass Control system includes a bypass valve, bypass control diaphragm, bypass control solenoid and 2 separate intake paths in the intake manifold. The Engine Control computer selects the proper air path based on present operating conditions. One path provides high engine torque at low RPM's while the other path produces high output at high RPM's.

Camshaft Position Sensor

Sends camshaft speed and position information to the ECU for spark timing or fuel injector control.

CAN

See Canister.

Canister (CAN)

The canister collects vapors from the fuel tank, preventing them from escaping into the

atmosphere and causing pollution. During warm engine cruise conditions these vapors are drawn into the engine and burned.

Canister Control Solenoid valve

Adjusts the amount of canister "purge" - the flow of vapors out of the canister.

Canister Purge solenoid

This device controls the flow of fuel vapors from the canister to the intake manifold.

CANP

See Canister Purge Solenoid.

CCE

Computer Controlled Emission system.

CE

See Check Engine light.

CEC

Computerized Engine Control.

Check Engine light (CE)

The Check engine light comes on when the ignition is turned on. It should go off a few seconds after the engine is started. The Check Engine light turns on to signal a problem. Some vehicles display trouble codes by flashing this light.

Closed Loop (C/L)

This is when a control system performs an action (expecting a certain result), then checks the results and corrects its actions (if necessary) until the desired results are achieved. Example: The ECU pulses a fuel injector expecting a certain amount of fuel to be delivered. In closed loop operation, the ECU uses a sensor to check the actual amount of fuel delivered. The ECU will correct the injector pulse width as necessary to obtain the desired fuel delivery.

Clutch Start Switch

Enables the Starter Relay when the clutch is depressed.

Clutch Switch

This switch tells the ECU when the clutch is engaged.

CO

Carbon Monoxide. Colorless, odorless and poisonous byproduct of fuel combustion.

Cold Start Injector

Delivers additional fuel for starting a cold engine.

Condenser

Also referred to as a Capacitor. This is an electronic device that stores an electrical charge. They are often used to reduce electrical noise.

Continuity

An unbroken, continuous circuit through which an electric current can flow.

Coolant Temperature Sensor (CTS or TW)

This sensor is a thermistor - a resistor whose resistance changes with temperature. The hotter the sensor gets, the lower the resistance becomes. The sensor is threaded into the engine block to give it direct contact with the engine coolant. The ECU uses engine temperature to properly control air/fuel mixture, spark advance, idle speed and emission device operation (such as EGR valve).

Coolant Temperature Switch (CTS)

A switch that opens or closes depending on coolant temperature.

Crankshaft Angle sensor (CRANK)

The Crankshaft angle sensor is mounted in the distributor. It sends crankshaft speed and position information to the ECU for spark timing or fuel injector control.

Crk/Cyl Sensor

Crankshaft/Cylinder Sensor. Detects position of Crankshaft and #1 Cylinder. Used by the ECU for spark timing or fuel injector control.

CTS

See Coolant Temperature Sensor or Coolant Temperature Switch.

Cylinder Head Temperature Sensor

The Cylinder Head Temperature sensor is mounted in the cylinder head usually near the thermostat. Temperature is usually measured by a thermistor - a resistor whose resistance changes with temperature. The hotter the sensor gets, the lower the resistance becomes.

Detonation Sensor (KMK)

The ECU uses this device to detect engine detonation (knocking). When spark knock occurs, the sensor sends a pulsing signal. The ECU then retards spark advance until no detonation is sensed. The sensor contains a piezoelectric element and is threaded into the engine block. Vibrating the element generates the signal. Special construction makes the element only sensitive to the engine vibrations associated with knocking.

Digital Signal

An electronic signal which has only two (2) voltage values: a "low" value (close to zero) and a "high" value (usually 5 volts or greater). Sometimes the low voltage condition is called "Off" and the high voltage condition is called "On". Signals which can have any voltage value are called "analog" signals.

Digital Volt Meter (DVM)

An instrument using a numeric readout to display measured voltage values as opposed to a moving needle on a gauge face. Usually the instrument has other measuring capabilities, such as resistance and current, and may be called a DMM (Digital Multi-Meter). Most DVM's have 10 Megohm input impedance. This means the circuit under test will not be electronically disturbed when the DVM is connected for a measurement.

Direct Ignition System (DIS)

DIS uses 1 ignition coil per spark plug. The coil is mounted directly to the spark plug (sometimes called a "coil per plug" system). No distributor or spark plug wires are used. Power to the coils is switched by the ECU or an ignition module. Information from various sensors is required to fire the proper coil at the correct time. The system needs to know crankshaft and camshaft position and speed, engine temperature, loading, throttle position and RPM.

DIS

See Direct Ignition System or Distributorless Ignition System.

Distributor

A mechanical device used to switch the high voltage, generated by the ignition coil, to the proper spark plug.

Distributorless Ignition system (DIS)

This system uses one ignition coil for each pair of cylinders. The cylinders are paired such that one is on the compression stroke while the other is on the exhaust stroke. When the coil is powered, spark plugs in both cylinders fire at the same time. The spark in the exhaust cylinder has no effect. (Which is why this method is sometimes called a "Wasted Spark" ignition system.) No distributor is used. Power to the coils is switched by the ECU or an ignition module. Information from various sensors is required to fire the proper coil at the correct time. The system needs to know crankshaft and camshaft position and speed, engine temperature, loading, throttle position and RPM.

Driver

A transistor "switch" inside the ECU used to apply power to an external device. This allows the ECU to control relays, solenoids and small motors.

Duty Cycle

A term applied to frequency signals - those which are

constantly switching between a small voltage value (close to zero) and a larger value (usually 5 volts or greater). Duty cycle is the percentage of time the signal has a large voltage value. For example, if the signal is "high" (large voltage) half of the time then the duty cycle is 50%. If the signal is "high" only one fourth of the time, then the duty cycle is 25%. A duty cycle of 0% means the signal is always at a "low" value and not changing. A duty cycle of 100% means the signal is always at a "high" value and not changing. The engine control computer uses duty cycle type signals when it wants more than just "on-off" control of an actuator. This is how it works: A 50% duty cycle signal going to a vacuum switching solenoid means the solenoid will be "on" (passing full vacuum) half the time and "off" (passing no vacuum) half the time. The average amount of vacuum passing through the solenoid will be one half of the full value because the solenoid is only "on" for one half of the time. (The signal switches at a rapid rate, such as ten times a second.) Thus, the computer can get a vacuum controlled actuator to move half way between "no vacuum" position and "full vacuum" position. Other positions can be achieved by changing the duty cycle of the control signal which in turn changes the average amount of control vacuum.

DVM

See Digital Volt Meter.

EABCV

See Electronic Air Bleed Control Valve.

EACV

See Electronic Air Control Valve.

Early Fuel Evaporation (EFE)

Early Fuel Evaporation refers to the heating of fuel while the engine is cold to aid in vaporization.

ECCS

See Electronic Concentrated Control System.

ECCS Relay

Supplies power to the ECCS.

ECT

Electronic Controlled Transmission.

ECU

See Electronic Control Unit.

EFE

See Early Fuel Evaporation.

EFI

See Electronic Fuel Injection.

EFI Main Relay

Supplies power to the engine control computer.

EGR

See Exhaust Gas Recirculation.

EGR Bimetallic Vacuum Switching Valve (EGR-BVSV)

Allows EGR operation above a predetermined temperature.

EGR Control Solenoid Valve

The ECU signals The EGR Control Solenoid Valve to enable or disable the recirculation of exhaust gases.

EGR Control valve

Controls the flow of exhaust gas back to the intake manifold. Helps to reduce poisonous NOx emissions.

EGR Temperature Sensor (EGR-TS)

The EGR Temperature sensor uses a Thermistor to measure the temperature of the exhaust gas passing through the EGR valve.

EGR Vacuum Modulator (EGR-VM)

Allows EGR operation at heavy throttle by balancing vacuum and atmospheric pressure and regulating exhaust back pressure.

EGR Vacuum Switching Valve (EGR-VSV)

Provides vacuum to appropriate system or device.

EGR Valve Lift Sensor or EGR Lift Sensor

Senses lift of EGR valve stem (the amount of valve opening). This signal is used by the ECU to calculate EGR flow at any time.

EGR-BVSV

See EGR Bimetallic Vacuum Switching Valve.

EGR-TS

See EGR Temperature Sensor.

EGR-VM

See EGR Vacuum Modulator.

EGR-VSV

See EGR Vacuum Switching Valve.

EGTS

See Exhaust Gas Temperature Sensor.

ELD

See Electric Load Detector.

Electric (Electrical) Load Detector (ELD)

This sensor notifies the ECU of any change in load upon the electrical system of the vehicle. The ECU will increase idle speed to prevent engine stalling due to heavy demands on the alternator.

Electromagnetic Interference (EMI)

Undesired signals interfering with a needed signal. For example: static on a radio brought about by lightning flashes or closeness to high voltage power lines.

Electronic (Electric) Air Control Valve (EACV)

Adjusts Idle speed by adjusting

the amount of air bypassing the throttle plate.

Electronic Air Bleed Control Valve (EABCV)

Used on carbureted vehicles. Operated by the ECU to control the Air/Fuel mixture.

Electronic Controlled Carburetor (ECC)

This carburetor system uses a computer to get information from various sensors. The computer then adjusts the operation of the carburetor to reduce emissions.

Electronic Concentrated Control System (ECCS)

A computerized system that controls the Fuel, Ignition and Emission systems based on information supplied by various sensors.

Electronic Control Unit (ECU)

A computerized unit that controls engine operation, and other systems, based on signals received from sensors.

Electronic Fuel Injection (EFI)

Any system where a computer controls fuel delivery to an engine by using fuel injectors.

Electronic Spark Advance (ESA)

The ECU controls spark advance based on information from various sensors. No mechanical or vacuum advance mechanisms are used.

EMI

See Electromagnetic Interference.

Engine Temperature Sensor

See Coolant Temperature Sensor.

ESA

See Electronic Spark Advance.

EVAP

See Evaporative Emission system.

EVAP Vapor Canister (EVAP-VC)

See Canister.

Evaporative Emission System (EVAP)

The EVAP system reduces the amount of fuel vapors entering the atmosphere. These vapors are stored in a charcoal canister. During warm engine cruise conditions the stored vapors are drawn into the engine and burned.

EVAP-VC

See Canister.

Exhaust Gas Recirculation (EGR)

The EGR system recirculates exhaust gases back into the intake manifold to reduce NO_x emissions. Various types of systems are in use on different vehicles. Usually the ECU directly controls EGR flow, but on some vehicles it may just activate a system controlled by non-electronic means. Vacuum controlled EGR valves are normally closed. Applying vacuum opens the valve.

Exhaust Gas Sensor

See Oxygen sensor.

Exhaust Gas Temperature Sensor (EGTS)

Measures the temperature of exhaust gases passing through the EGR valve.

Fan Switch

Controls radiator cooling fan.

Fast Idle Control Device (FICD)

The Fast Idle Control Device controls idle speed while air conditioning is activated and when engine is running.

Feedback Carburetor

This is used on early versions of computer controlled engines. It is a carburetor which can have its air/fuel delivery modified by an electronic signal from the ECU.

FICD

See Fast Idle Control Device.

Frequency

The frequency of an electronic signal is a measure of how often the signal repeats a voltage pattern in a one second time span. For example: suppose a signal starts at zero volts, goes to five volts then returns to zero again. If this pattern repeats itself 100 times in one second, then the signal frequency is 100 cycles per second - or 100 Hertz.

Fuel Cut Solenoid

Interrupts fuel delivery during deceleration if the throttle is closed and RPM is above some minimum value. Used to increase fuel economy and reduce emissions.

Fuel Injector

An electronically controlled flow valve. Fuel injectors are connected to a pressurized fuel supply. (The pressure is created by a fuel pump.) No flow occurs when the injector is off (not energized). When the injector is powered, it opens fully allowing the fuel to flow. The ECU controls fuel delivery by varying the amount of time the injectors are turned on.

Fuel Injector Relay

Supplies power to the fuel injectors.

Fuel Injector resistors

Limits the electrical current to the fuel Injector(s).

Fuel Rail

The pipe assembly that supplies fuel to the injectors and offers mechanical support.

Fuel Temperature Sensor

Measures the temperature of fuel in the fuel rail.

Ground

The return path for current to flow back to its source. (Usually the negative battery terminal.) It is also the reference point from which voltage measurements are made. That is, it is the connection place for the minus (-) test lead from the voltmeter.

HAC

See High Altitude Compensator.

Hard Failures

Hard failures cause the Check Engine light (if equipped) to come on or flash. The Check Engine light (if equipped) will not stay off until the problem has been corrected.

HC

See Hydrocarbons.

Hertz (Hz)

A term for frequency - cycles per second.

High Altitude Compensator (HAC)

Adjusts the Air/Fuel mixture for changes in altitude.

Hydrocarbons (HC)

Polluting byproducts of fuel combustion.

IACV

See Intake Air Control Valve.

I.C. Ignition Unit

Solid state ignition control unit.

Idle Control System

This system maintains correct idle speed when the engine experiences mechanical or electrical load changes.

Idle Mixture Adjuster (IMA)

Maintains proper Air/Fuel ratio while at idle.

Idle Speed Control (ISC)

Maintains proper idle speed when engine loading changes.

Idle Switch

Signals the ECU when the throttle is in the closed (idle) position.

Idle-Up Solenoid

The Idle-Up solenoid assists the AAC or FICD when the engine is under heavy load. It controls idle speed by adjusting throttle bypass air.

Ignition Coil

A transformer designed to boost the battery voltage to the high voltage required to cause a spark and ignite the air/fuel mix in the engine's cylinder.

Igniter unit

The Igniter is an electronic switch which energizes the ignition coil. The Igniter is controlled by the ECU or pick up coil.

I/A

See Integrated Ignition Assembly.

IMA

See Idle Mixture Adjuster.

Inhibitor Switch

This switch is located on the Automatic transmission/transaxle. It signals the ECU when the gearshift lever is in the Neutral or Park position.

Inputs

Electrical signals running into the ECU. These signals come from sensors, switches or other electronic modules. They give the ECU information about vehicle operation.

Intake Air control Valve (IACV)

Controls the amount of intake air flowing into the intake manifold.

Intake Air Temperature Sensor

This sensor is a thermistor - a resistor whose resistance

changes with temperature. The hotter the sensor gets, the lower the resistance becomes. The sensor is located along the path of air entering the engine. The ECU uses intake air temperature to provide the proper air/fuel mixture for the desired engine operating condition.

Intake Control System

The Engine Control computer uses the Intake Control system to select one of two air paths in the intake manifold. The proper air path is based on operating conditions. One path provides high engine torque at low RPM's while the other path produces high output at high RPM's.

Integrated Ignition Assembly (IIA)

The Integrated Ignition Assembly refers to the distributor containing the ignition coil and other ignition components.

Intercooler

Cools the intake air after compression by the turbocharger.

Intermittent Failures

Intermittent failures may cause the Check Engine (if equipped) light to illuminate or flicker. The Check Engine light (if equipped) will go off when the problem is no longer sensed. The trouble code will remain in memory.

Knock Sensor (KNC)

See Detonation sensor.

LAF

See Linear Air Fuel Ratio sensor.

LED

Light Emitting Diode. A semiconductor device which acts like a miniature light bulb. When a small voltage is applied, the LED glows. LED's may be red, orange, yellow or green. They are often used as indicators or in numeric displays.

Linear Air/Fuel Ratio sensor (LAF)

The LAF sensor is similar to an Oxygen sensor.

Lock-Up Control solenoid Valve

Controls locking of the torque converter when signaled by the ECU. This reduces transmission slippage and increases fuel economy.

MAF

See Mass Airflow sensor.

Main Relay

Usually contains two relays. One for power to the Engine Control Computer, Fuel Injectors and the second relay. The second relay supplies power to the Fuel pump.

Manifold Absolute Pressure sensor (MAP)

This sensor is an electronic module which sends a signal to the ECU indicating atmospheric pressure and/or engine vacuum. Depending upon sensor type, the signal may be a dc voltage or a frequency. More pressure (less vacuum) makes the sensor signal increase (higher voltage or frequency). The ECU needs to know air pressure both outside and inside the manifold to properly adjust air/fuel mixture and ignition timing for varying engine load and altitude conditions.

MAP

See Manifold Absolute Pressure.

Mass Air Flow sensor (MAF)

Also referred to as Mass Airflow Meter, this sensor measures the amount of air entering the engine and sends a signal to the ECU. Depending upon sensor type, the signal may be a voltage or frequency. The signal voltage (or frequency) increases when the amount of incoming air goes up. This gives the ECU information required for control of fuel delivery, spark advance and EGR flow.

Mode

A type of operating condition, such as "idle mode" or "cruise mode."

M/T

Manual Transmission or Manual Transaxle.

Neutral switch

This switch is mounted on the Manual transmission/Transaxle. It signals the ECU when the gearshift lever is in the Neutral position.

O₂

Oxygen. See Oxygen sensor.

Open (circuit)

A break in the continuity of a circuit such that no electrical current can flow.

Open Loop (O/L)

This is when a control system performs an action (expecting a certain result), but has no way of verifying if the desired results were achieved. Example: The ECU pulses a fuel injector expecting a certain amount of fuel to be delivered. (The ECU assumes everything in the fuel system is operating as expected.) In open loop operation, the ECU has no way of checking the actual amount of fuel delivered. Thus, a faulty injector or incorrect fuel pressure can change the amount of fuel delivered and the ECU would not know it.

Outputs

Electrical signals sent from the ECU. These signals may activate relays or other actuators for control purposes around the vehicle. The signals can also send information from the ECU to other electronic modules, such as ignition or trip computer.

Oxygen Sensor (O₂ Sensor)

The Oxygen (O₂) sensor measures the amount of oxygen in the exhaust gas and signals the ECU. The ECU uses this information to maintain the correct Air/Fuel ratio.

PA Sensor

(Pressure - Atmosphere.) See Atmospheric Pressure Sensor.

Park Switch

Informs the ECU when the gearshift lever is in the Park position.

PCV

See Positive Crankcase Ventilation.

PFI

See Port Fuel Injection.

PGM-FI

See Programmed Fuel Injection.

Port Fuel Injection (PFI)

A fuel injection system using one injector per cylinder. These injectors are mounted in the intake manifold and usually fired in groups.

Positive Crankcase Ventilation (PCV)

The PCV valve allows blow-by gases from the engine's crankcase to be drawn into the intake manifold and into the air cleaner to be burned in combustion.

Power Transistor

A heavy duty transistor usually used as an electronic switch to control loads such as the ignition coil.

Power Transistor Relay

Supplies power to ignition coil(s).

Pressure Regulator Valve (PRV)

Maintains proper fuel pressure in the fuel rail for the fuel injectors.

Programmed Fuel Injection (PGM-FI)

A Fuel Injection system in which a control unit identified as an ECU, (or similar name), adjusts the amount of fuel injected into the cylinder or throttle body

based upon information from various sensors.

PRV

See Pressure Regulator Valve.

Pulse Generator

See TDC/CRANK/CYL.

Relay

A mechanical device for switching high current circuits on and off. It is electronically controlled by a low current circuit. Relays allows a low power ECU signal to control a high power device such as an electric cooling fan.

Resistor

An electronic device that limits electrical current flow.

ROM

Read-Only Memory. This is inside the ECU. The ROM contains permanent programming information the ECU needs to operate a specific vehicle model. Included are vehicle weight, engine and transmission type, axle ratio and other specifics.

Safety Relay

Supplies power to the fuel pump relay and protects some electronic components from being damaged by reverse battery polarity.

Sensor

Device which give the ECU information. The ECU can only work with electrical signals. The job of the sensor is to take something the ECU needs to know, such as engine temperature, and convert it to an electrical signal which the ECU can understand. The ECU uses sensors to measure such things as throttle position, coolant temperature, engine speed, incoming air, etc.

SFI

See Sequential Fuel Injection.

Sequential Fuel Injection (SFI)

Also referred to as Sequential Electronic Fuel Injection. A fuel injection system using one injector for each cylinder. The

injectors are mounted in the intake manifold. The injectors are fired individually in the same sequence as the spark plug firing sequence.

Short (circuit)

A fault condition: an unwanted connection of one electric circuit to another causing a change in the normal current flow path.

Solenoid

A device to convert an electrical current to mechanical motion. It consists of a coil of wire with a movable metal rod in the center. When power is applied to the coil, the resulting electromagnetism moves the rod and performs some mechanical action. The ECU often uses solenoids to switch vacuum lines on and off. This allows the ECU to control vacuum operated devices such as an EGR valve. Fuel injectors are another type of solenoid.

SPK

Abbreviation for Spark.

SPK-BVSV

Spark Control Bimetallic Vacuum Switching Valve.

Starter Relay

Supplies power to the starter motor.

Starter Signal

This signal notifies the ECU when the engine is cranking.

Stepper Motor

A special type of electric motor with a shaft that rotates in small "steps" instead of a continuous motion. A certain sequence of frequency type signals is required to step the motor shaft. A different signal sequence will step the shaft in the opposite direction. No signals keeps the shaft still in position. A constant signal drive will continuously rotate the shaft. The shaft is usually connected to a threaded assembly which moves back and forth to control things such as idle speed. The engine computer sends the correct signals to the motor for control.

TA Sensor

(Temperature - Air.) See Air Temperature Sensor.

TBI

See Throttle Body Injection.

TCCS

See Toyota Computer Control System.

TDC

See Top Dead Center.

TDC/CRANK/CYL or TDC/CRANK

This is a group of three sensors usually located within the Distributor. The TDC signal determines timing while cranking and detects an abnormal crank angle signal. The CRANK signal represents engine RPM. The CYL signal represents the NO.1 cylinder position. The ECU uses these signals for ignition and fuel injector control.

Thermistor

A resistor whose resistance changes with temperature. Thermistors are used as sensors for vehicle coolant and manifold air temperature. The resistance decreases as temperature goes up.

Throttle Angle Sensor

See Throttle Position Sensor.

Throttle Body

A device resembling a carburetor but using Electronic Fuel Injector(s) in place of the Fuel circuit of a carburetor.

Throttle Body Injection (TBI)

A fuel injection system consisting of fuel injector(s) located in a Throttle Body.

Throttle Position Sensor or Switch (TP or TPS)

The throttle position sensor consists of a Potentiometer or a Switch that notifies the ECU of throttle position.

Throttle Sensor

See Throttle Position Sensor.

Throttle Valve Idle switch

Signals the ECU when the throttle is in the idle position.

Top Dead Center (TDC)

When a piston is at its uppermost position in the cylinder - maximum compression.

Toyota Computer Control System (TCCS)

A computerized unit that controls engine operation and other systems using information received from sensors.

TPS

See Throttle Position Sensor.

TW Sensor

(Temperature - Water.) See Coolant Temperature Sensor.

Vacuum Switch or Sensor

A switch or sensor whose output depends on vacuum.

Vacuum Switching Valve (VSV)

Provides vacuum to appropriate system or device.

Valve Timing Oil Pressure Switch

This switch signals the ECU when the Variable Valve Timing Electronic Control (VTEC) system is operating.

Variable Valve Timing Electronic Control (VTEC)

A system of controlling the opening of the intake valves. The VTEC Spool Valve is used to control the valves.

Vehicle Speed Pulser

See Vehicle Speed Sensor.

Vehicle Speed Sensor (VSS)

Vehicle Speed Sensor. This sensor, mounted in the transmission, sends a frequency signal to the ECU. The frequency increases as the vehicle moves faster to give the ECU vehicle speed information.

VSS

See Vehicle Speed Sensor.

VSV

See Vacuum Switching Valve.

VTEC

See Variable Valve Timing Electronic Control.

Wide Open Throttle (WOT)

The vehicle operating condition brought about when the throttle is completely (or nearly so) open. The ECU typically delivers extra fuel to the engine at this time for acceleration purposes. The ECU uses the Throttle Position sensor, or a switch, to identify the WOT condition.

WOT

See Wide Open Throttle.

ONE (1) YEAR LIMITED WARRANTY

Actron Manufacturing Company ("Actron") warrants to the original purchaser that this product will be free from defects in materials and workmanship for a period of one (1) year from the date of original purchase. Any unit that fails within this period will be replaced or repaired at Actron's discretion without charge. If you need to return product, please follow the instructions below. This warranty does not apply to damages (intentional or accidental), alterations or improper or unreasonable use.

DISCLAIMER OF WARRANTY

ACTRON DISCLAIMS ALL EXPRESS WARRANTIES EXCEPT THOSE THAT APPEAR ABOVE. FURTHER, ACTRON DISCLAIMS ANY IMPLIED WARRANTY OF MERCHANTABILITY OF THE GOODS OR FITNESS OF THE GOODS FOR ANY PURPOSE. (TO THE EXTENT ALLOWED BY LAW, ANY IMPLIED WARRANTY OF MERCHANTABILITY OR OF FITNESS APPLICABLE TO ANY PRODUCT IS SUBJECT TO ALL THE TERMS AND CONDITIONS OF THIS LIMITED WARRANTY. SOME STATES DO NOT ALLOW LIMITATIONS ON HOW LONG AN IMPLIED WARRANTY LASTS, SO THIS LIMITATION MAY NOT APPLY TO A SPECIFIC BUYER.)

LIMITATION OF REMEDIES

IN NO CASE SHALL ACTRON BE LIABLE FOR ANY SPECIAL, INCIDENTAL OR CONSEQUENTIAL DAMAGES BASED UPON ANY LEGAL THEORY INCLUDING, BUT NOT LIMITED TO, DAMAGES FOR LOST PROFITS AND/OR INJURY TO PROPERTY. SOME STATES DO NOT ALLOW THE EXCLUSION OR LIMITATION OF INCIDENTAL OR CONSEQUENTIAL DAMAGES, SO THIS LIMITATION OR EXCLUSION MAY NOT APPLY TO A SPECIFIC BUYER. THIS WARRANTY GIVES YOU SPECIFIC LEGAL RIGHTS, AND YOU MAY ALSO HAVE OTHER RIGHTS WHICH VARY FROM STATE TO STATE.

TO USE YOUR WARRANTY

If you need to return the unit, please follow this procedure:

1. Call Actron Tech Support at (800) 253-9880. Our Technical Service representatives are trained to assist you.
2. Proof of purchase is required for all warranty claims. Please retain your sales receipt.
3. In the event that product needs to be returned, you will be given a Return Material Authorization number.
4. If possible, return the product in its original package with cables and accessories.
5. Print the RMA number and your return address on the outside of the package and send to the address provided by your Customer Service representative.
6. You will be responsible for shipping charges in the event that your repair is not covered by warranty.

OUT OF WARRANTY REPAIR

If you need product repair after your warranty has expired, please call Tech Support at (800) 253-9880. You will be advised of the cost of repair and any freight charges.

All information, illustrations and specifications contained in this manual are based on the latest information available from industry sources at the time of publication. No warranty (expressed or implied) can be made for its accuracy or completeness, nor is any responsibility assumed by Actron or anyone connected with it for loss or damages suffered through reliance on any information contained in this manual or misuse of accompanying product. Actron reserves the right to make changes at any time to this manual or accompanying product without obligation to notify any person or organization of such changes.



ACTRON MANUFACTURING CO.
15825 Industrial Parkway
Cleveland, Ohio 44135-3319

1-800-228-7667